

Name: _____

Grade: _____

Date: _____

Uppercase Alphabet Trace Practice

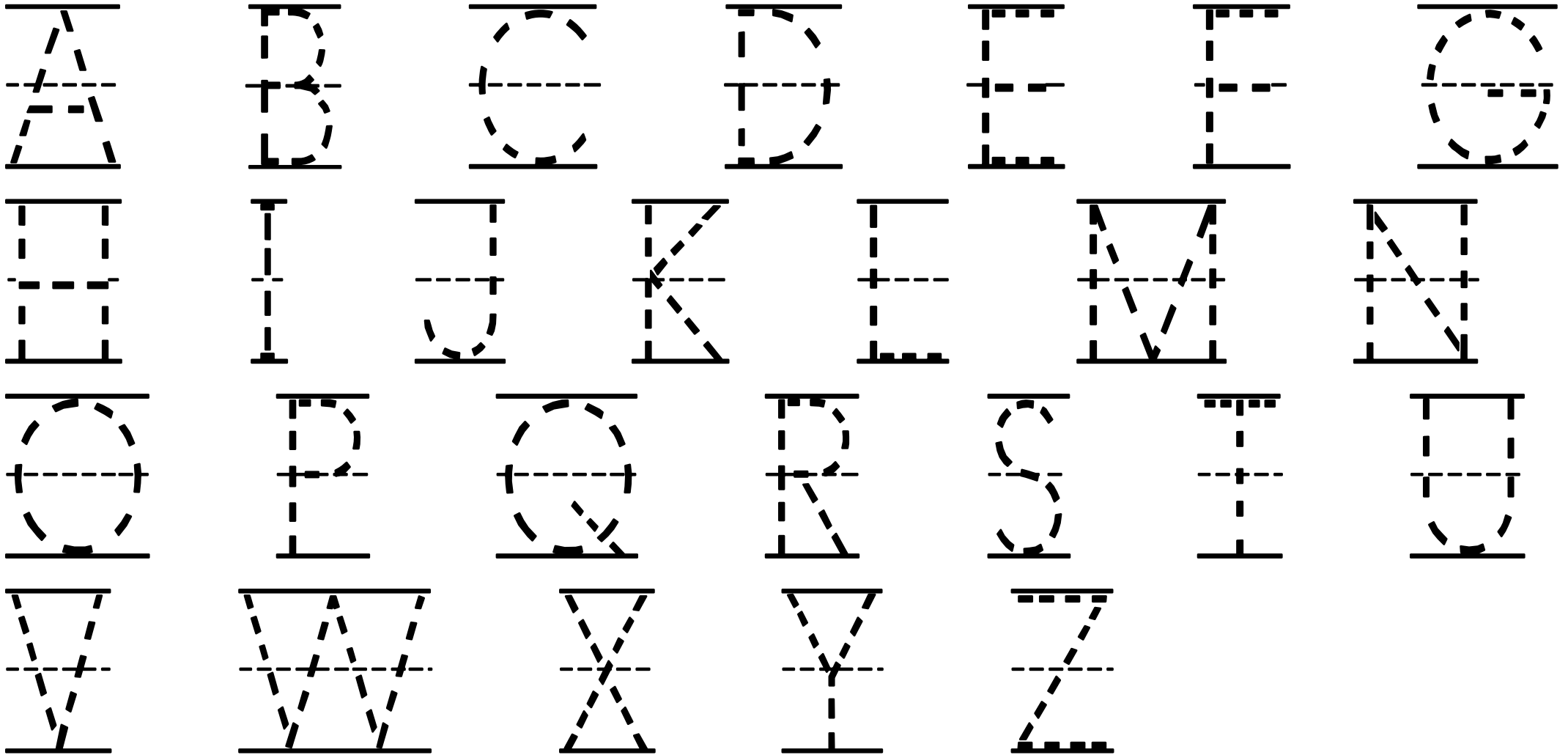

Name: _____

Grade: _____

Date: _____

Lowercase Alphabet Trace Practice

Tracing practice for lowercase letters a through z. Each letter is shown on a set of three horizontal lines (top, middle, bottom) and is rendered in a dashed format for tracing. The letters are arranged in five rows:

- Row 1: a, b, c, d, e, f, g
- Row 2: h, i, j, k, l, m, n
- Row 3: o, p, q, r, s, t, u
- Row 4: v, w, x, y, z

Name: _____

Grade: _____

Date: _____

Alphabet 'A a' Practice Flash card

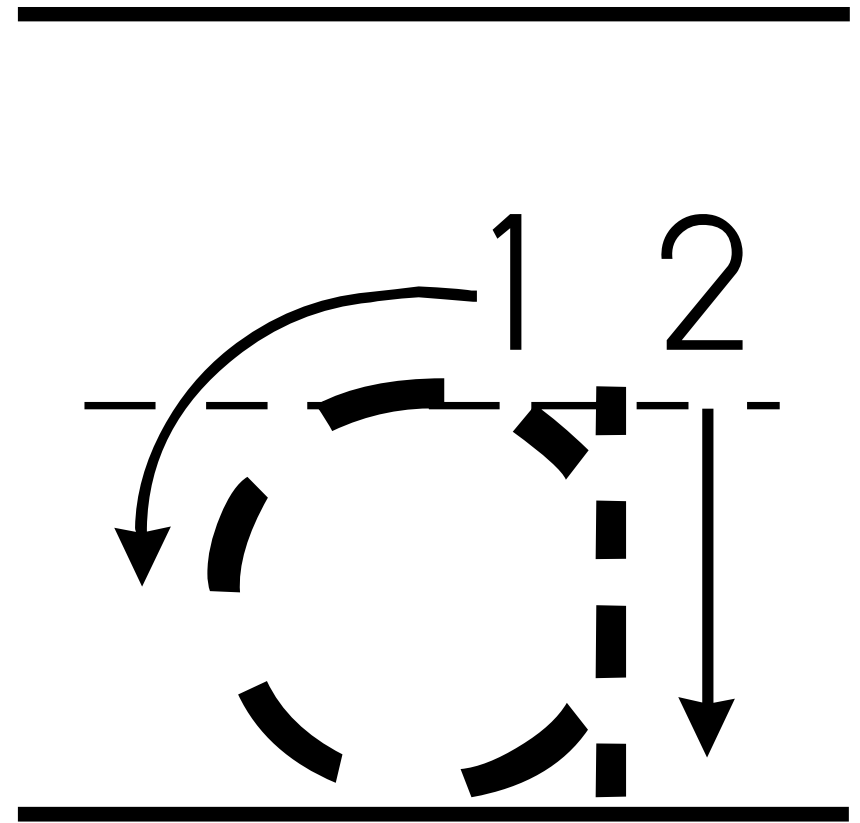
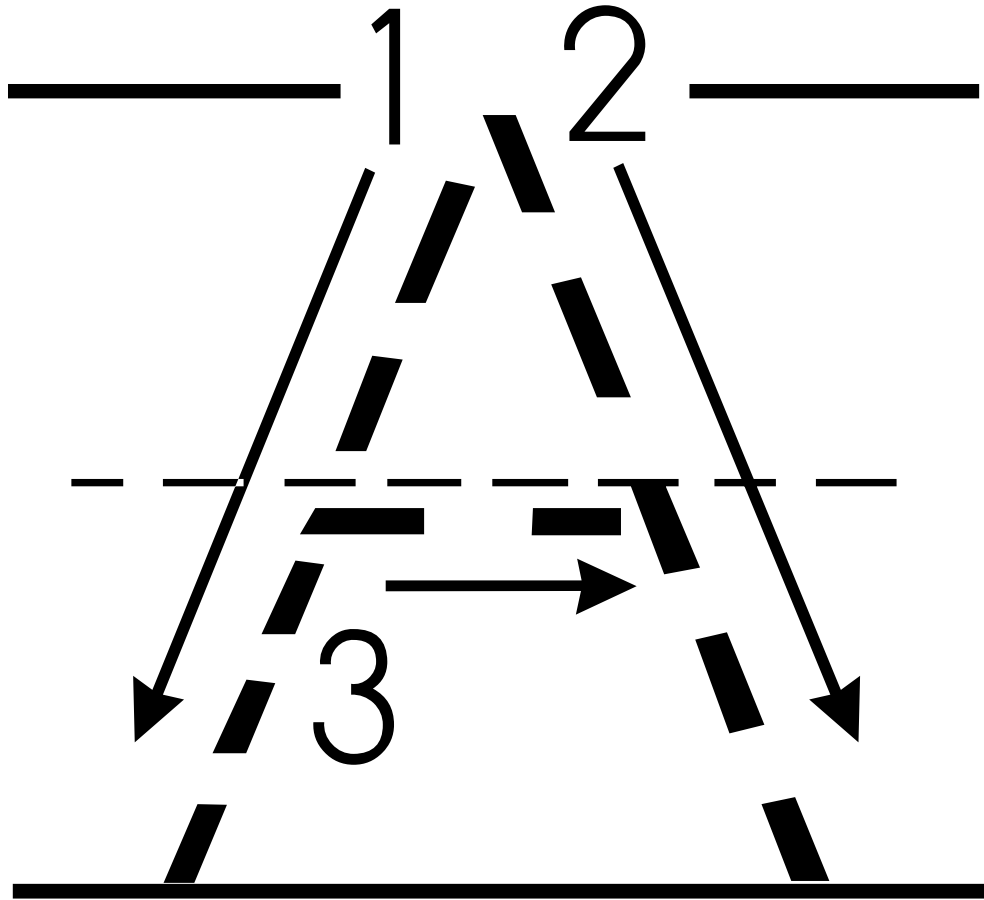

Name: _____

Grade: _____

Date: _____

Alphabet 'B b' Practice Flash card

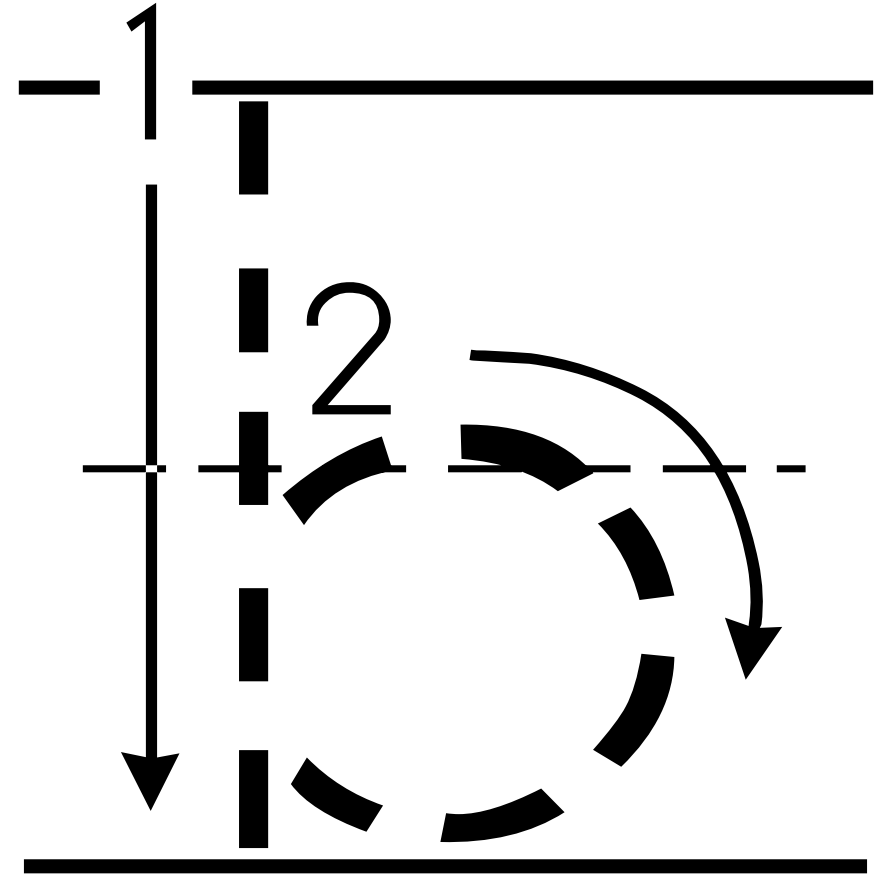
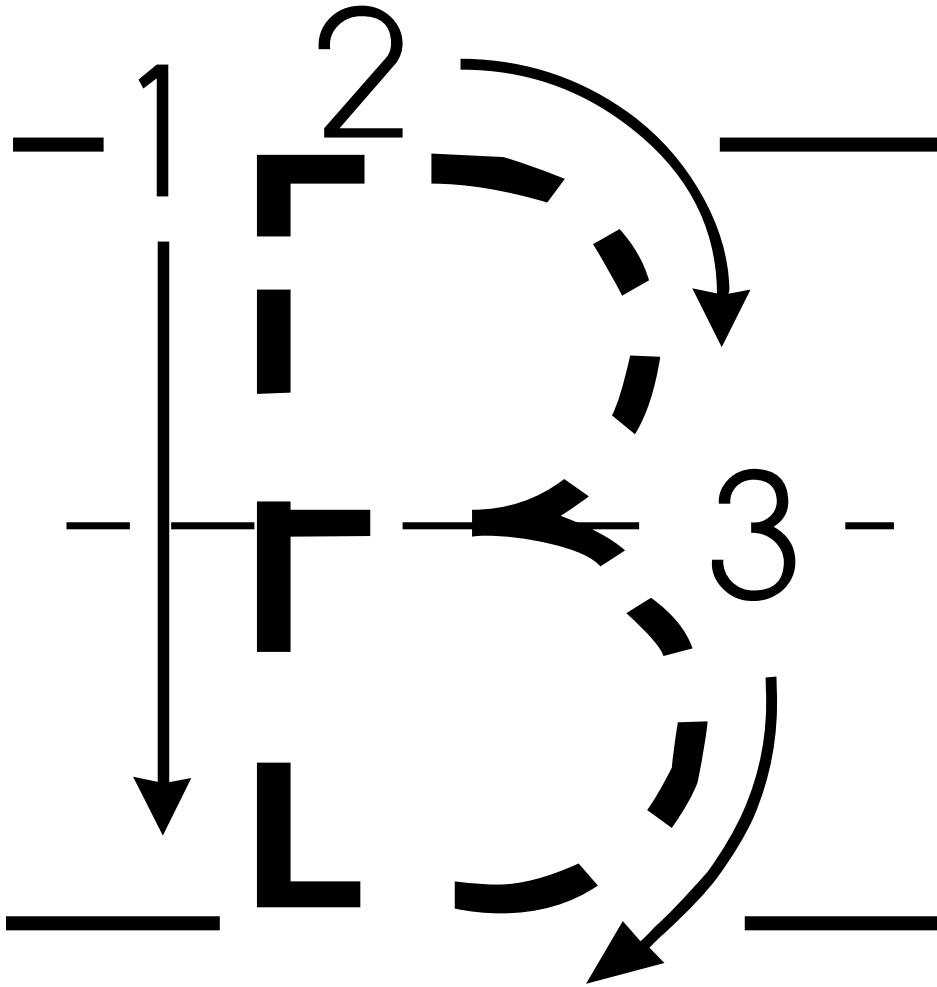

Name: _____

Grade: _____

Date: _____

Alphabet 'C c' Practice Flash card

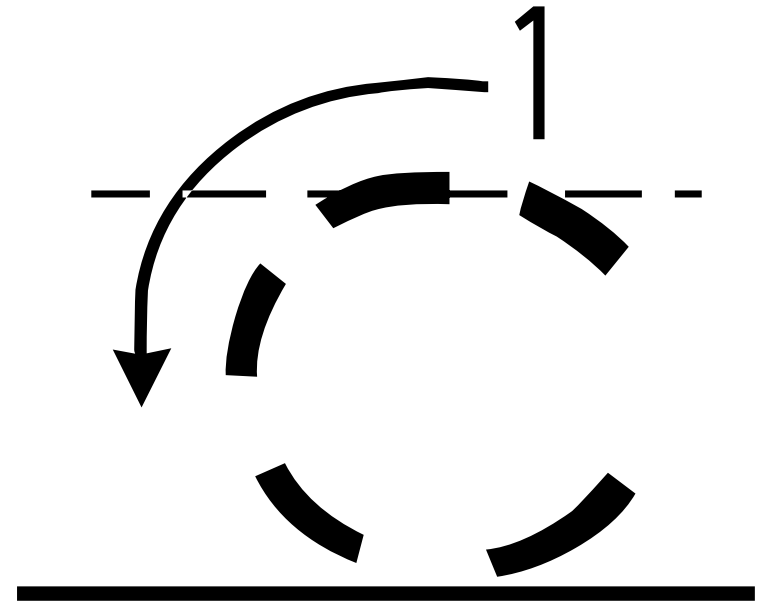
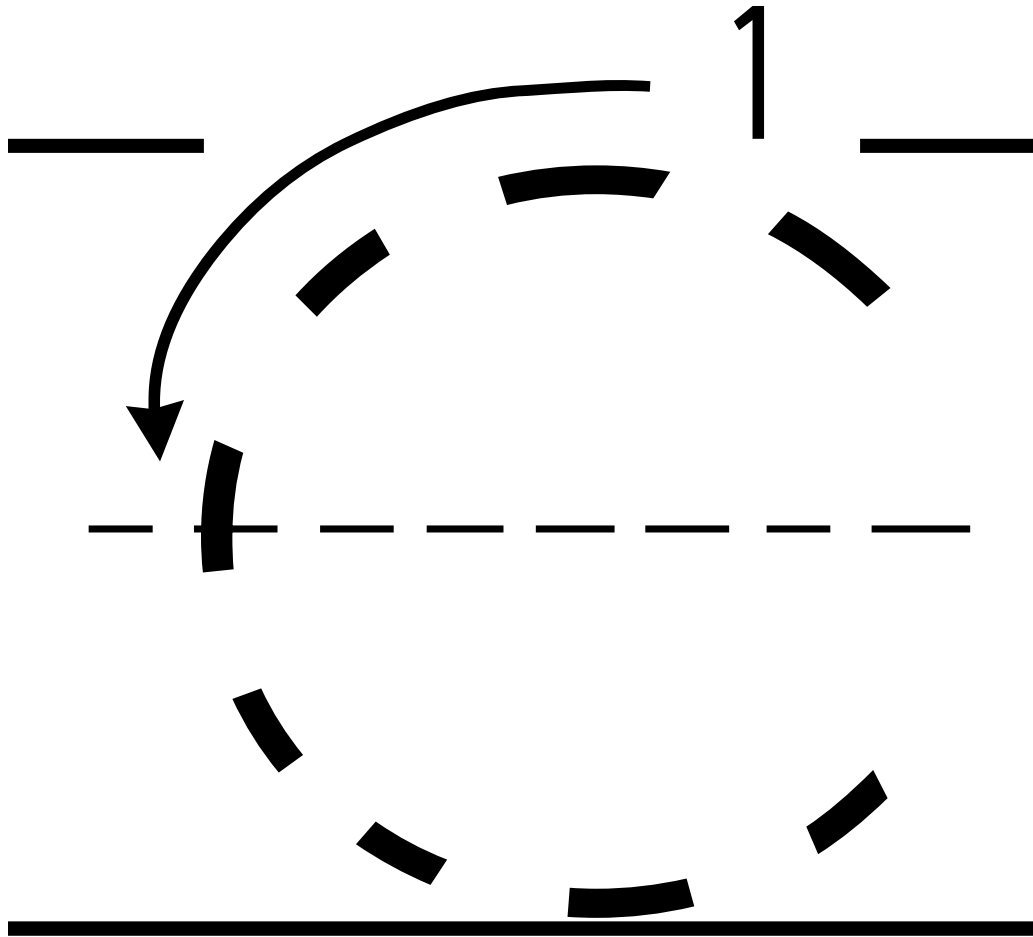

Name: _____

Grade: _____

Date: _____

Alphabet 'D d' Practice Flash card

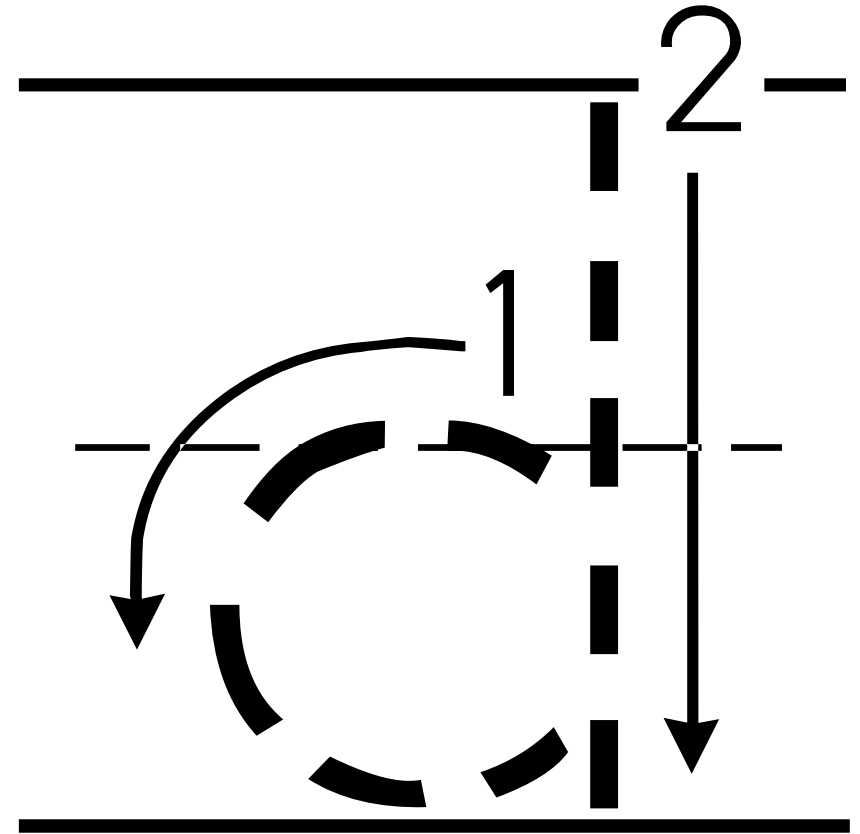
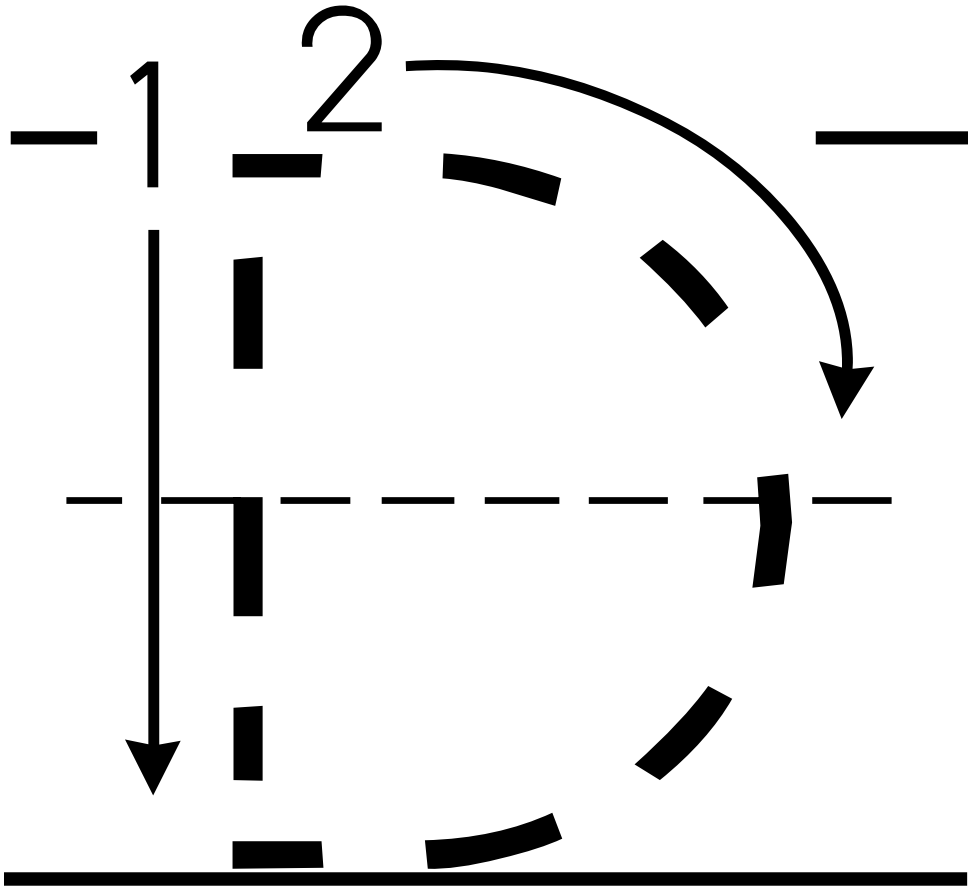

Name: _____

Grade: _____

Date: _____

Alphabet 'E e' Practice Flash card

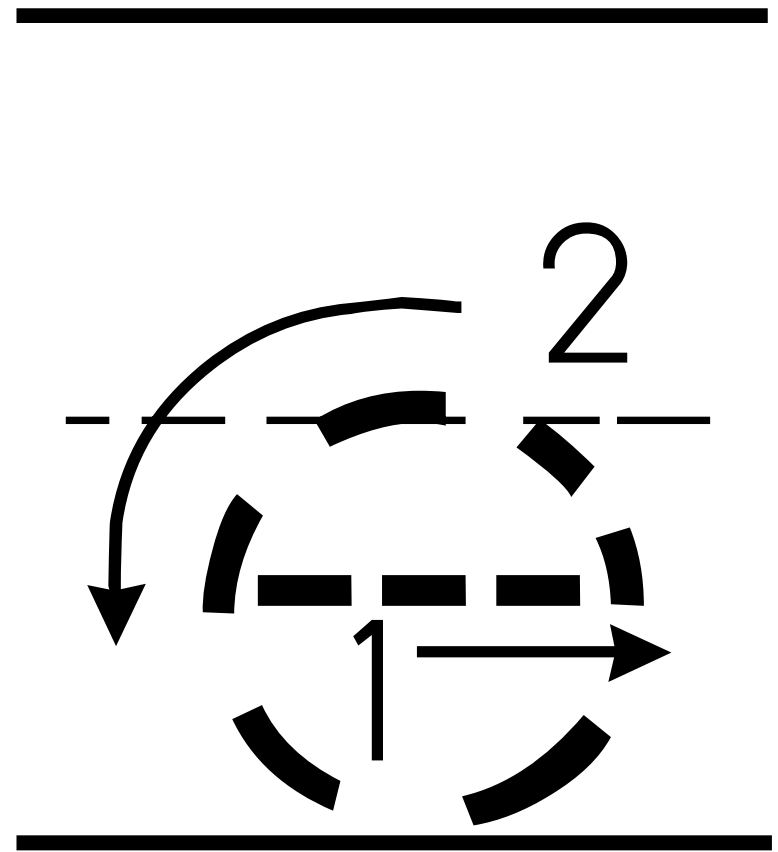
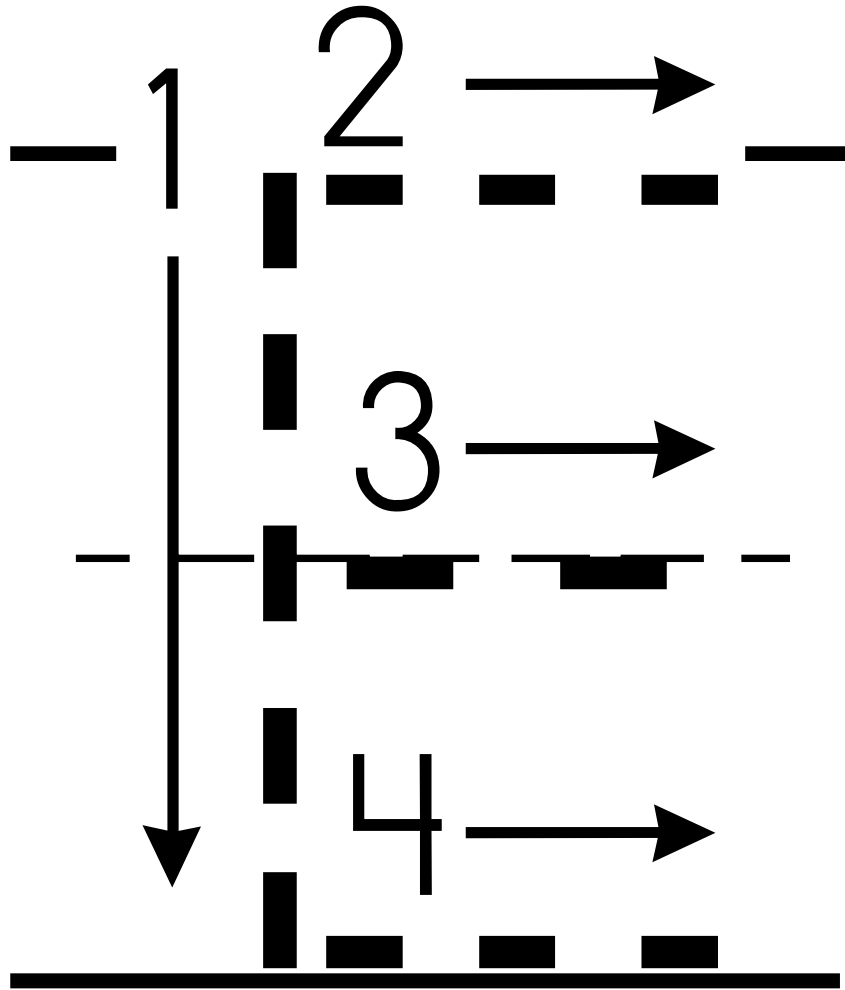

Name: _____

Grade: _____

Date: _____

Alphabet 'F f' Practice Flash card

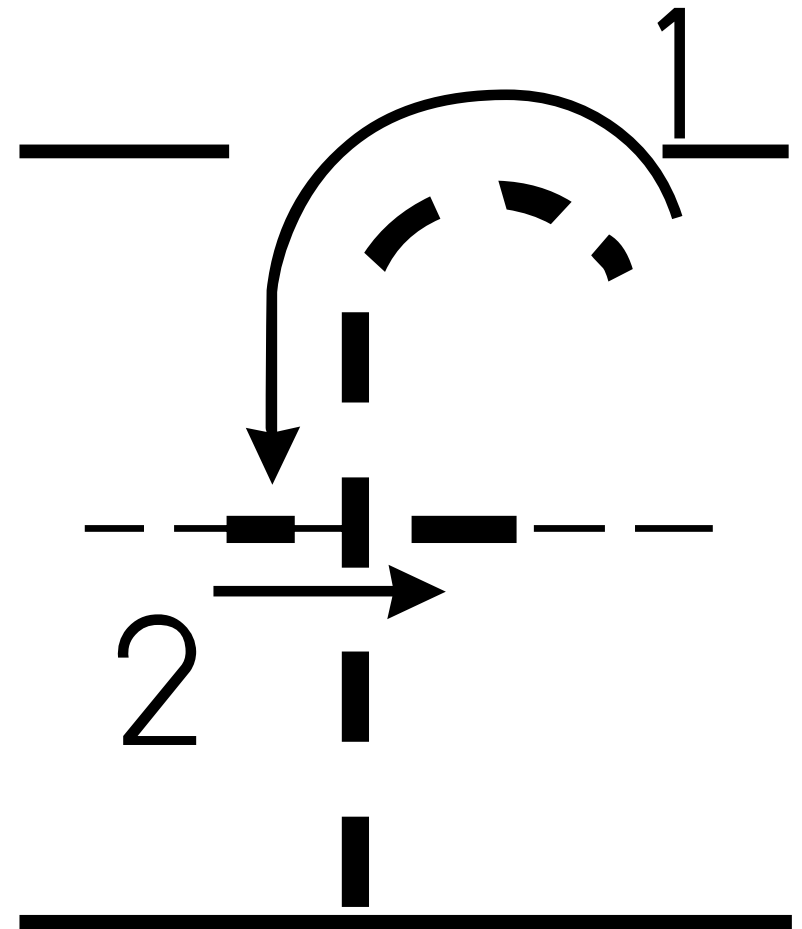
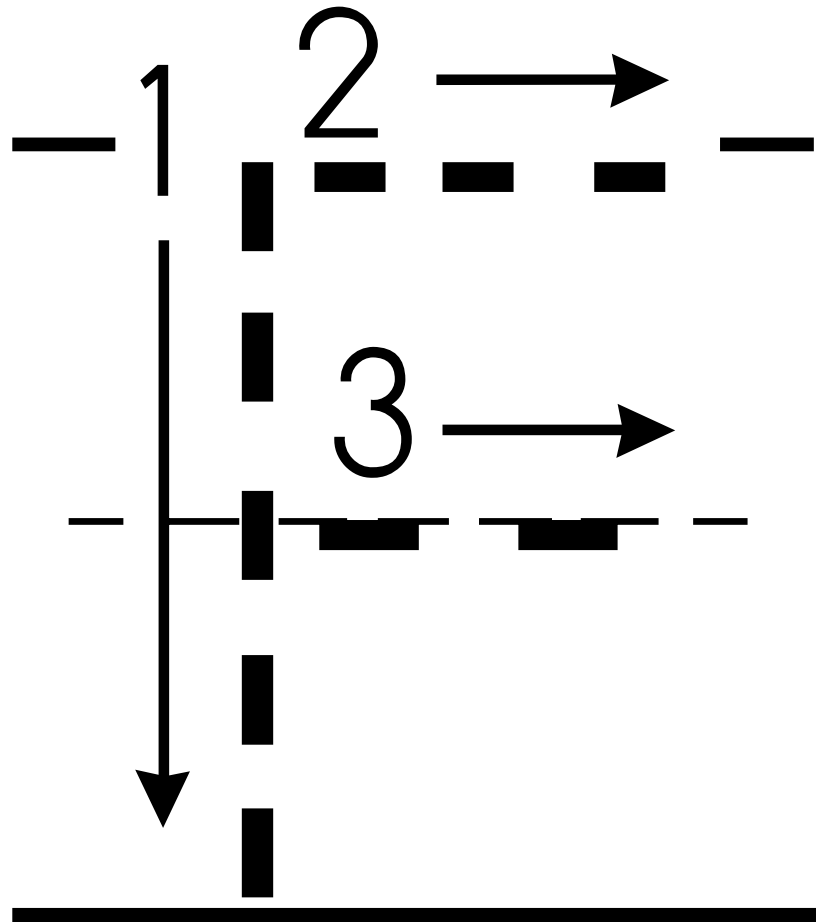

Name: _____

Grade: _____

Date: _____

Alphabet 'G g' Practice Flash card

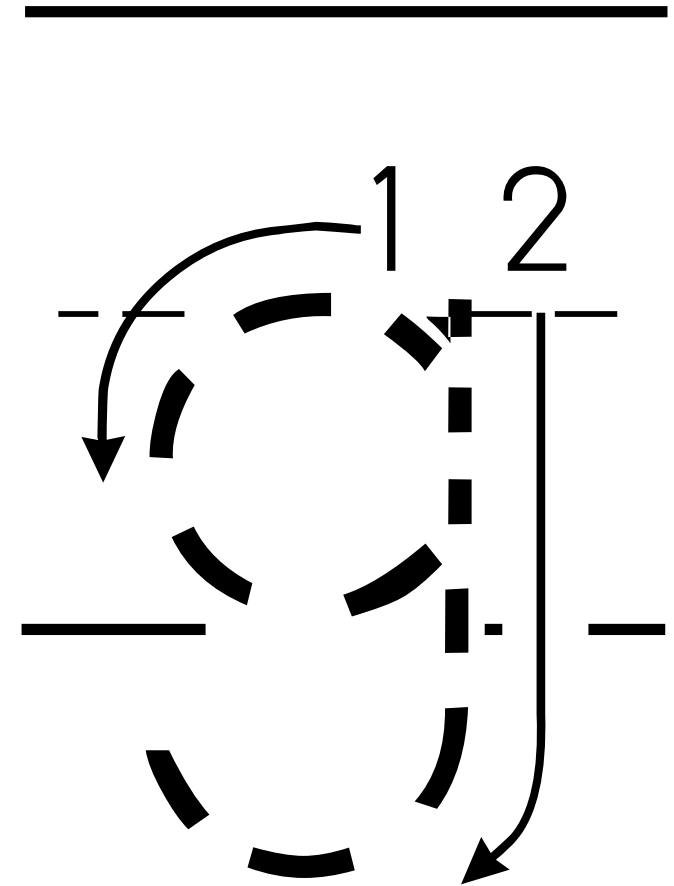
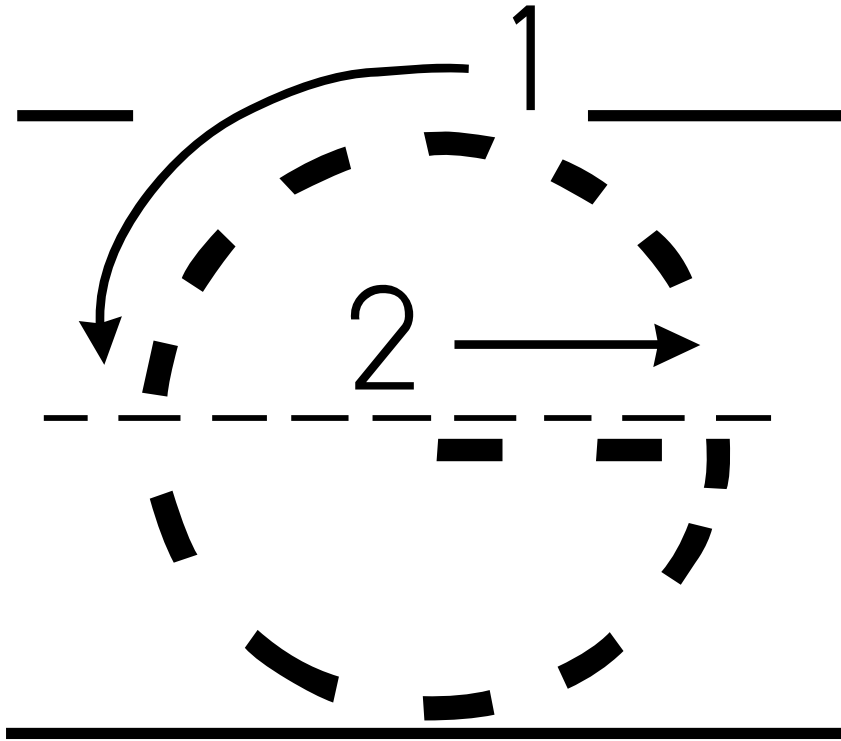

Name: _____

Grade: _____

Date: _____

Alphabet 'H h' Practice Flash card

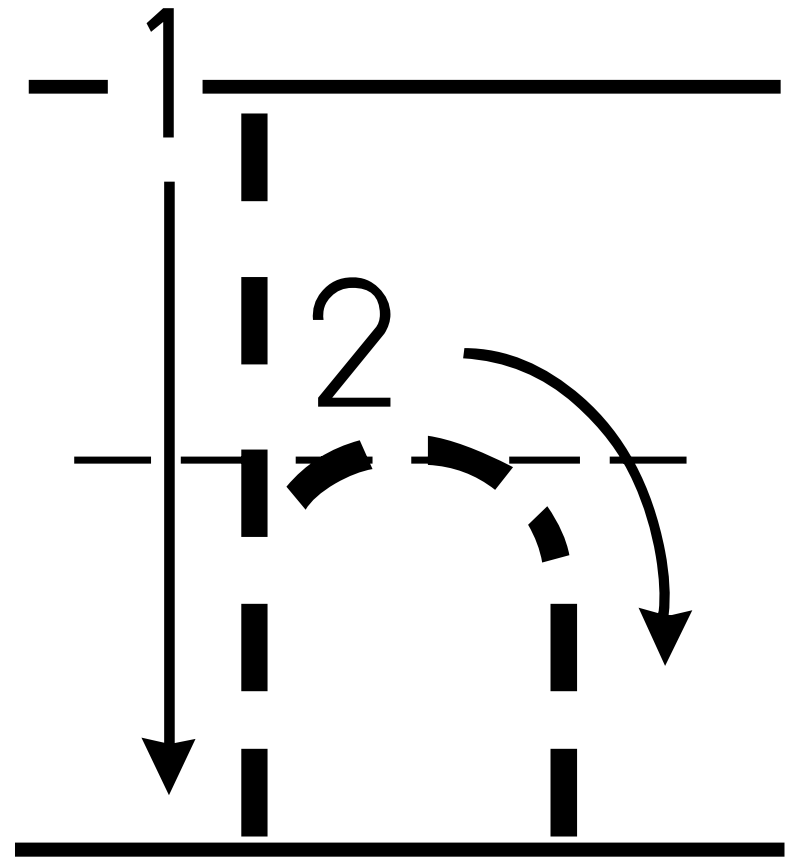
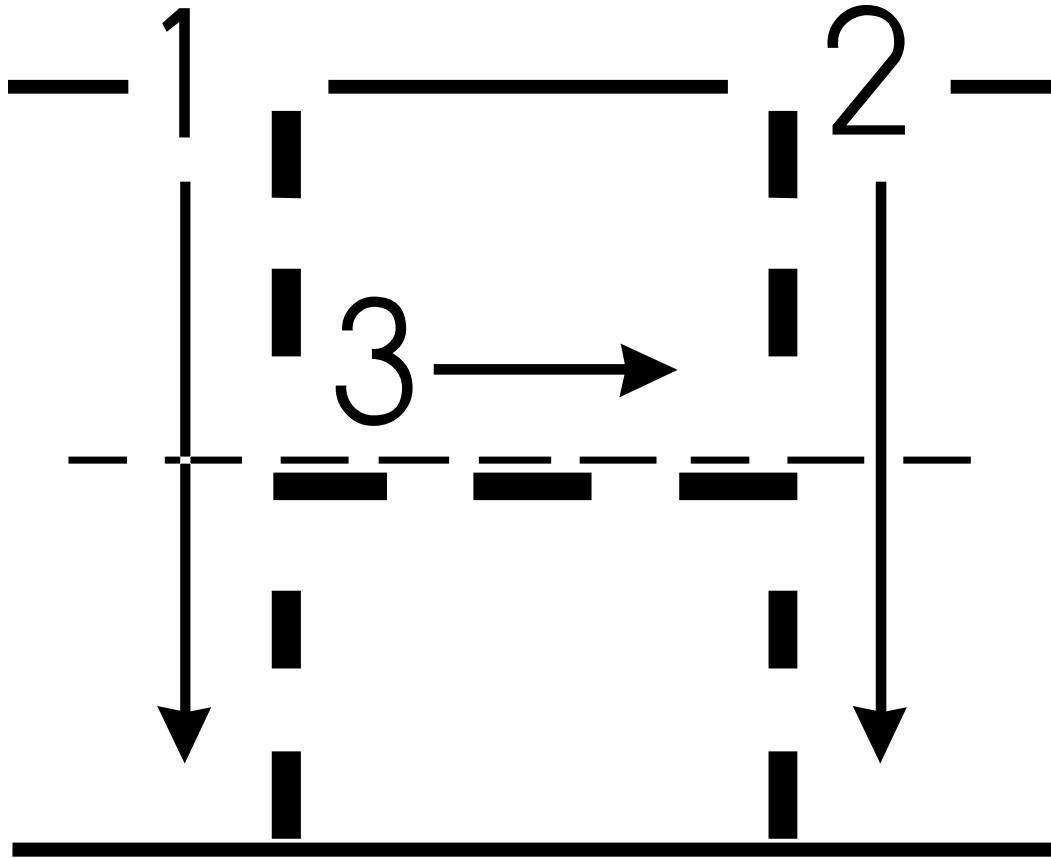

Name: _____

Grade: _____

Date: _____

Alphabet 'I i' Practice Flash card

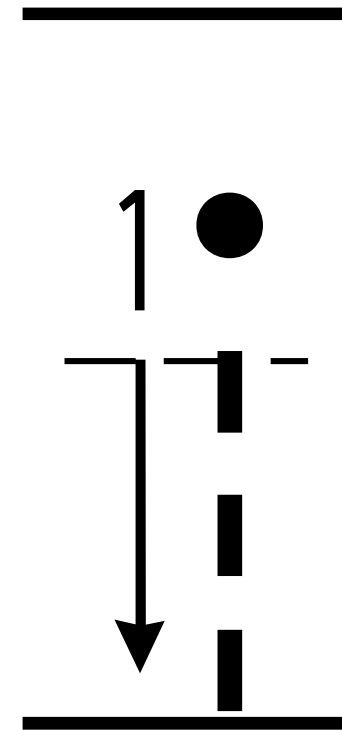
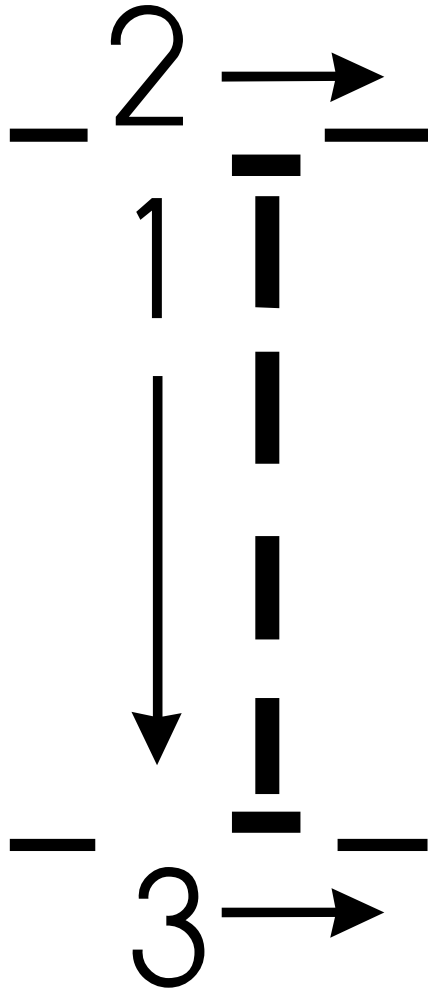

Name: _____

Grade: _____

Date: _____

Alphabet 'J j' Practice Flash card

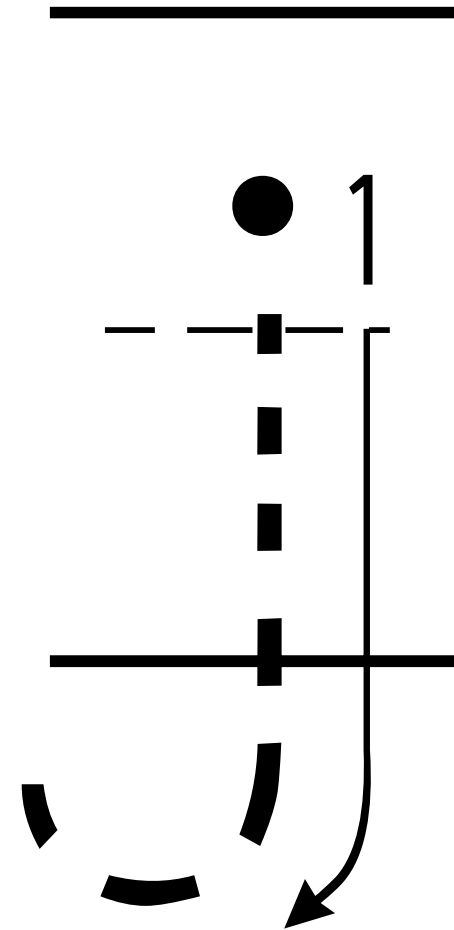
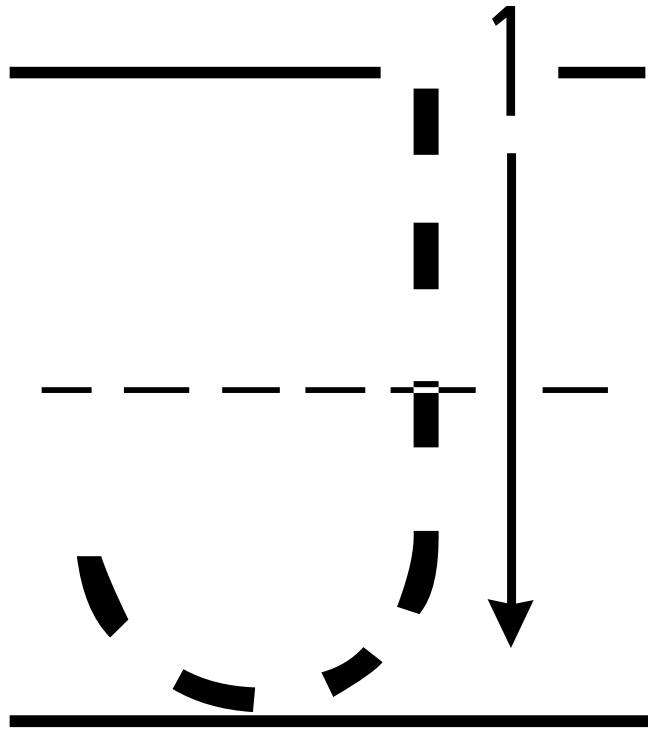

Name: _____

Grade: _____

Date: _____

Alphabet 'K k' Practice Flash card

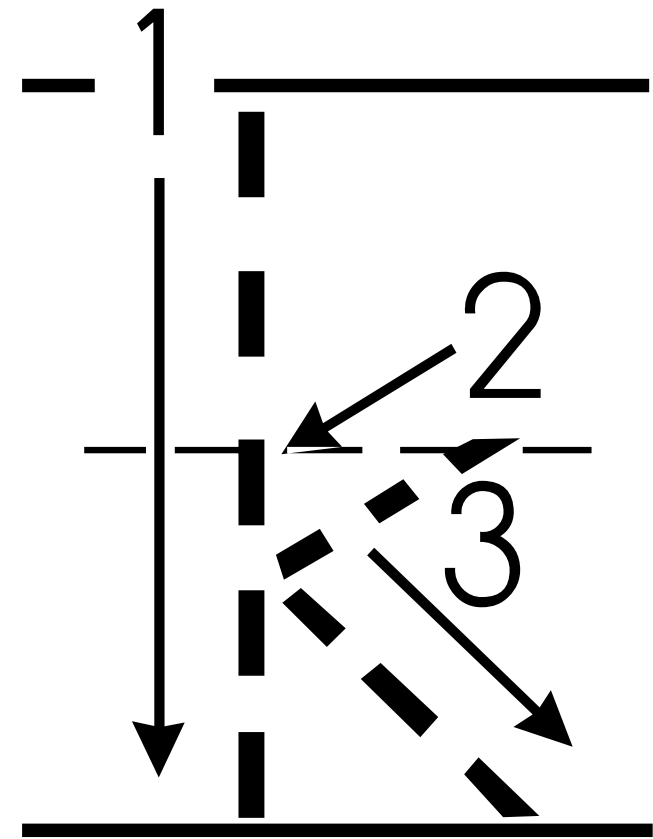
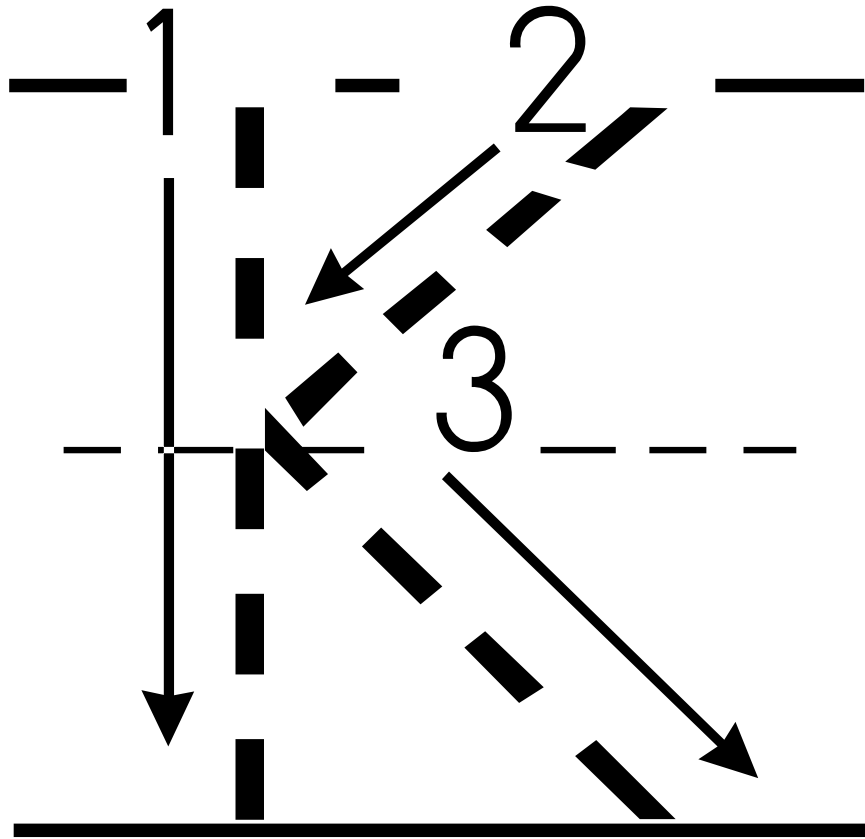

Name: _____

Grade: _____

Date: _____

Alphabet 'L l' Practice Flash card

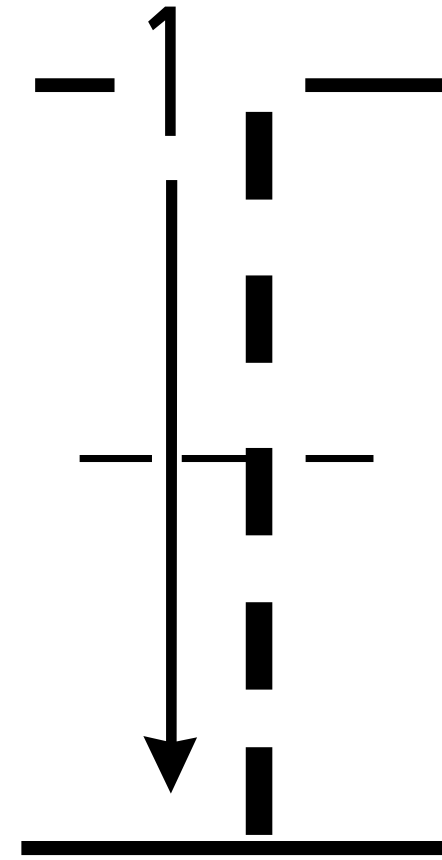
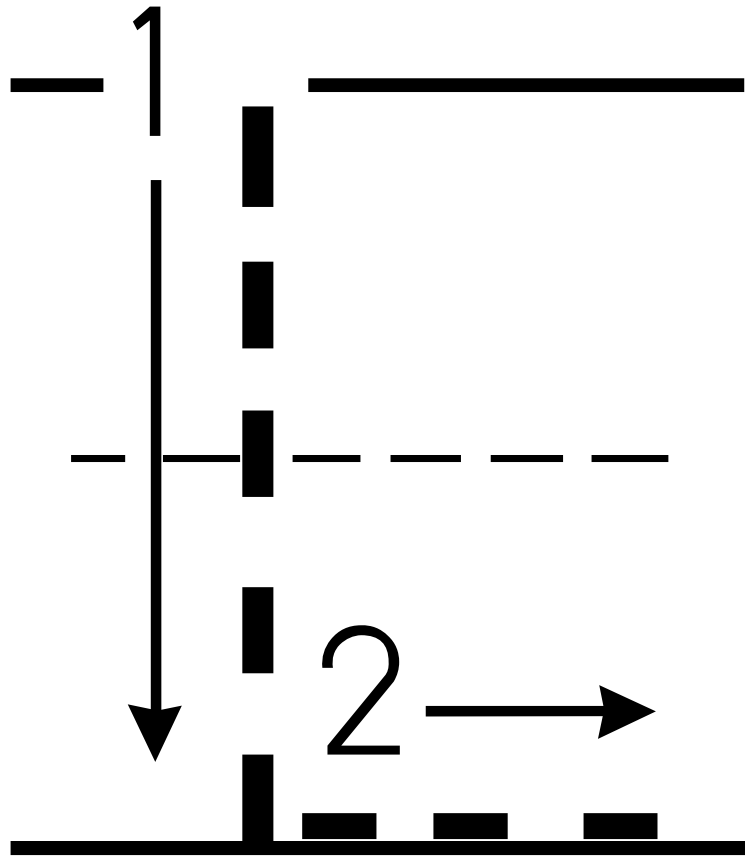

Name: _____

Grade: _____

Date: _____

Alphabet 'M m' Practice Flash card

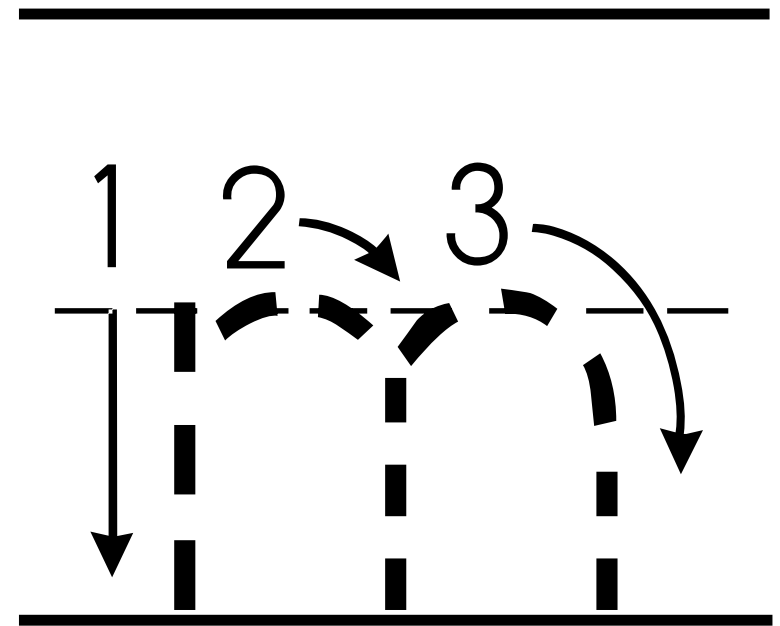
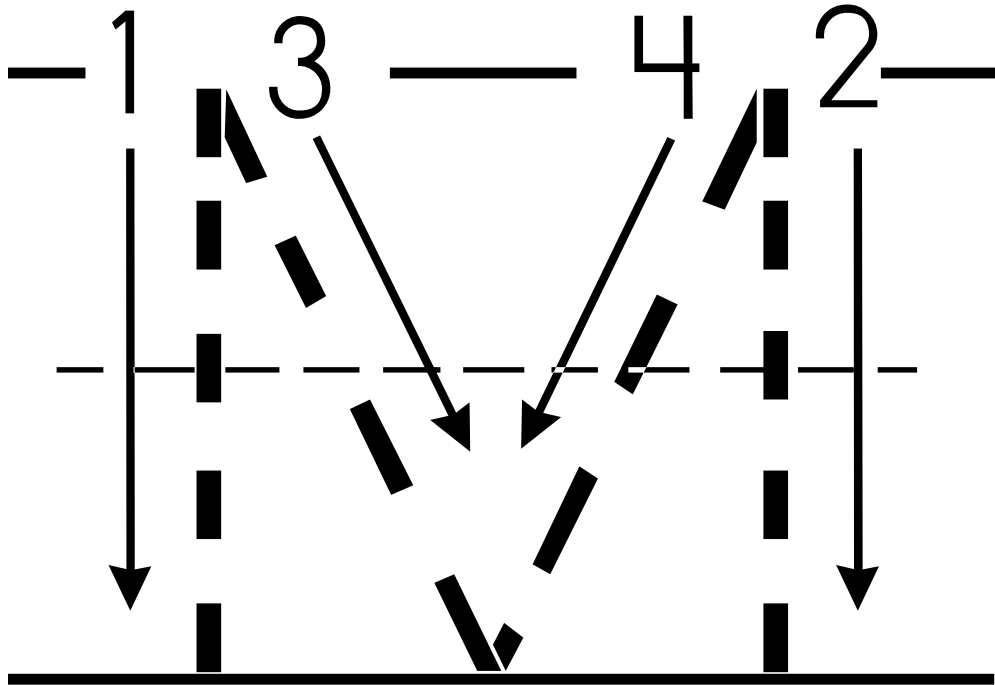

Name: _____

Grade: _____

Date: _____

Alphabet 'N n' Practice Flash card

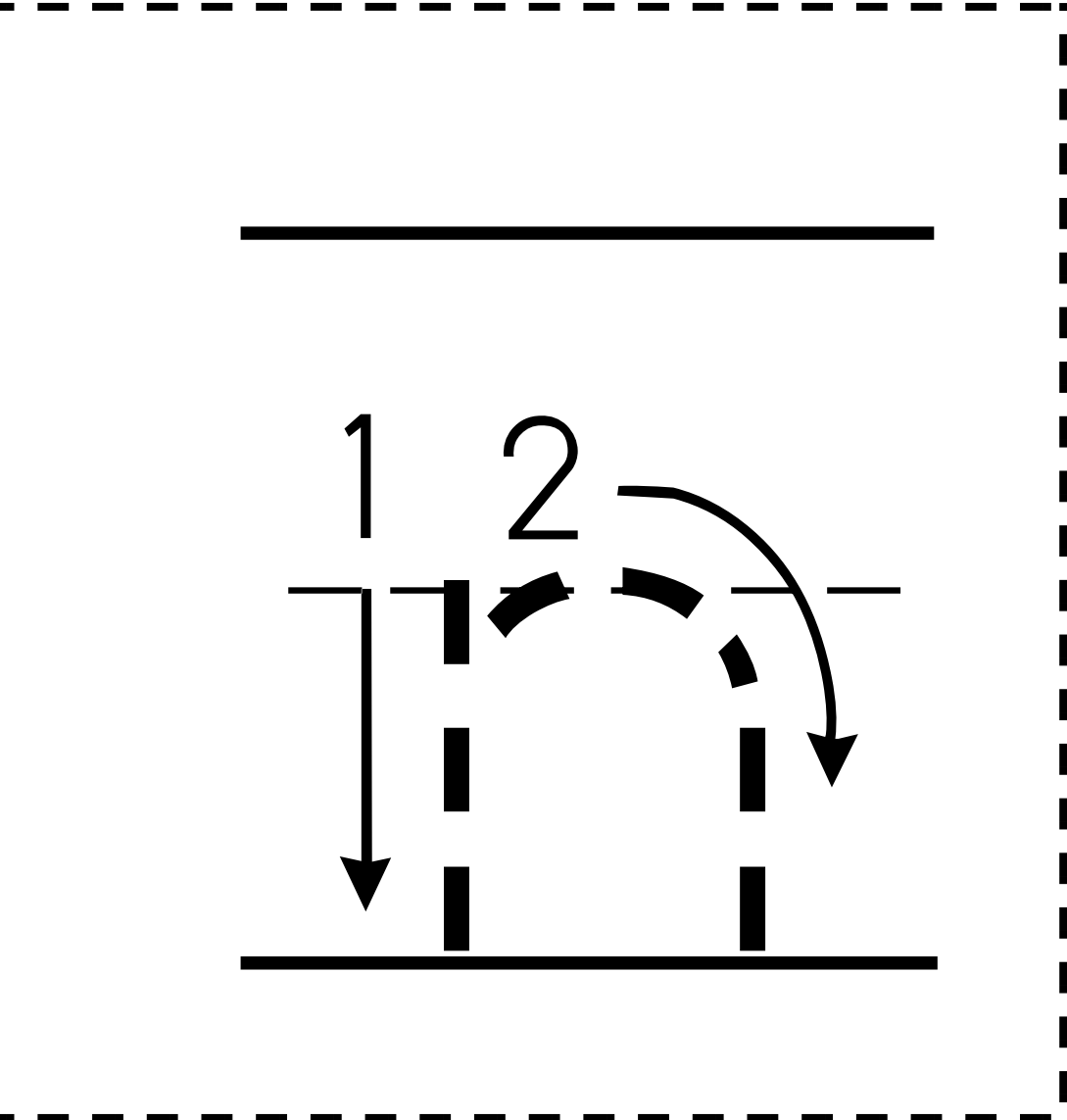
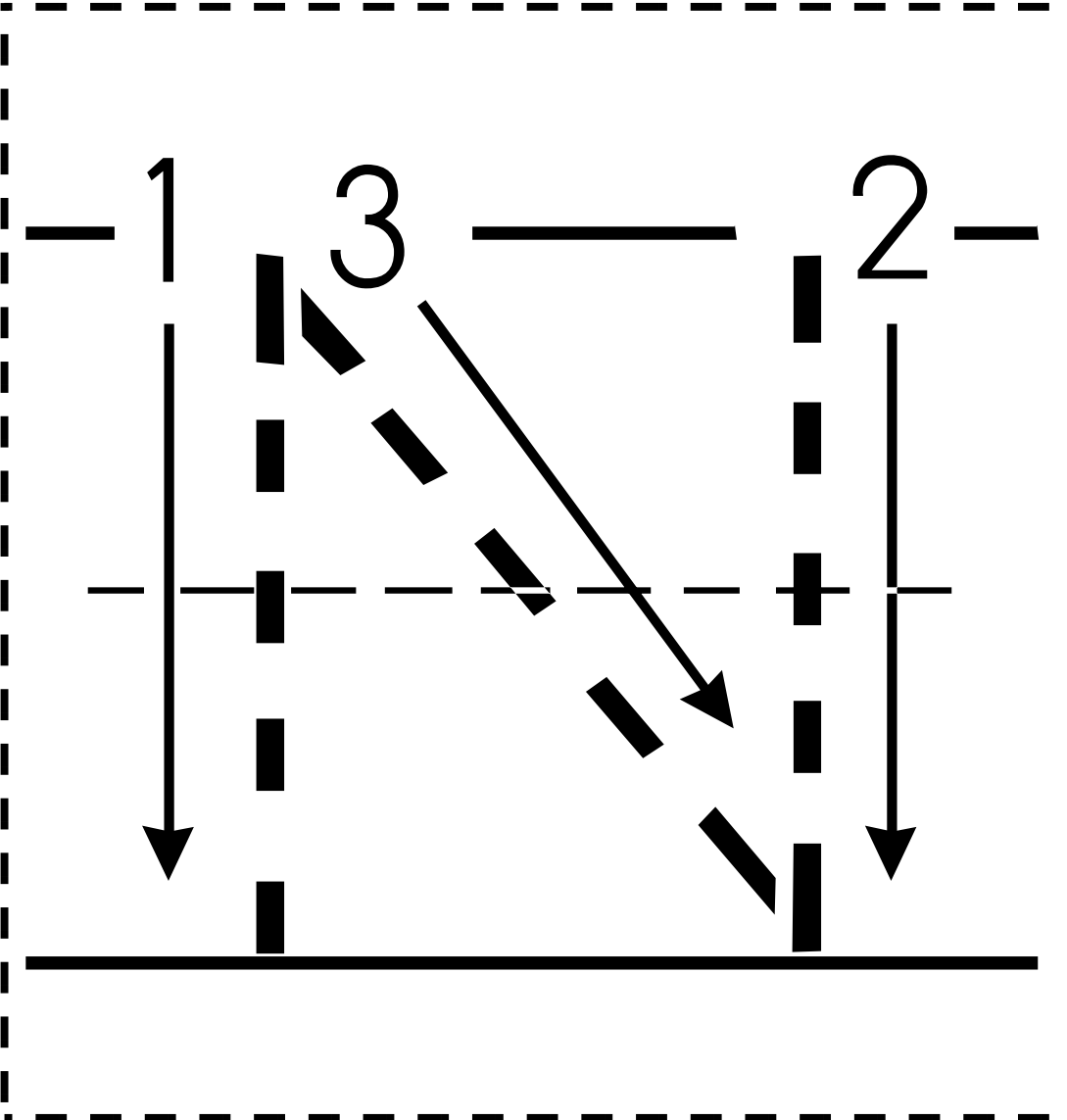

Name: _____

Grade: _____

Date: _____

Alphabet 'O o' Practice Flash card

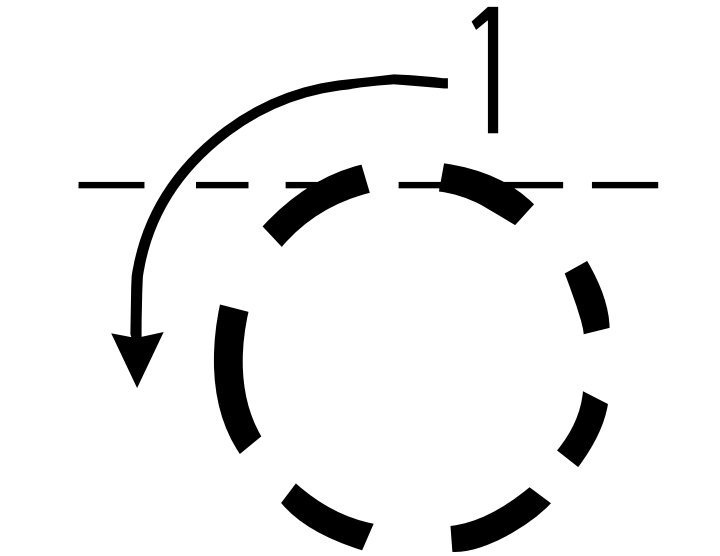
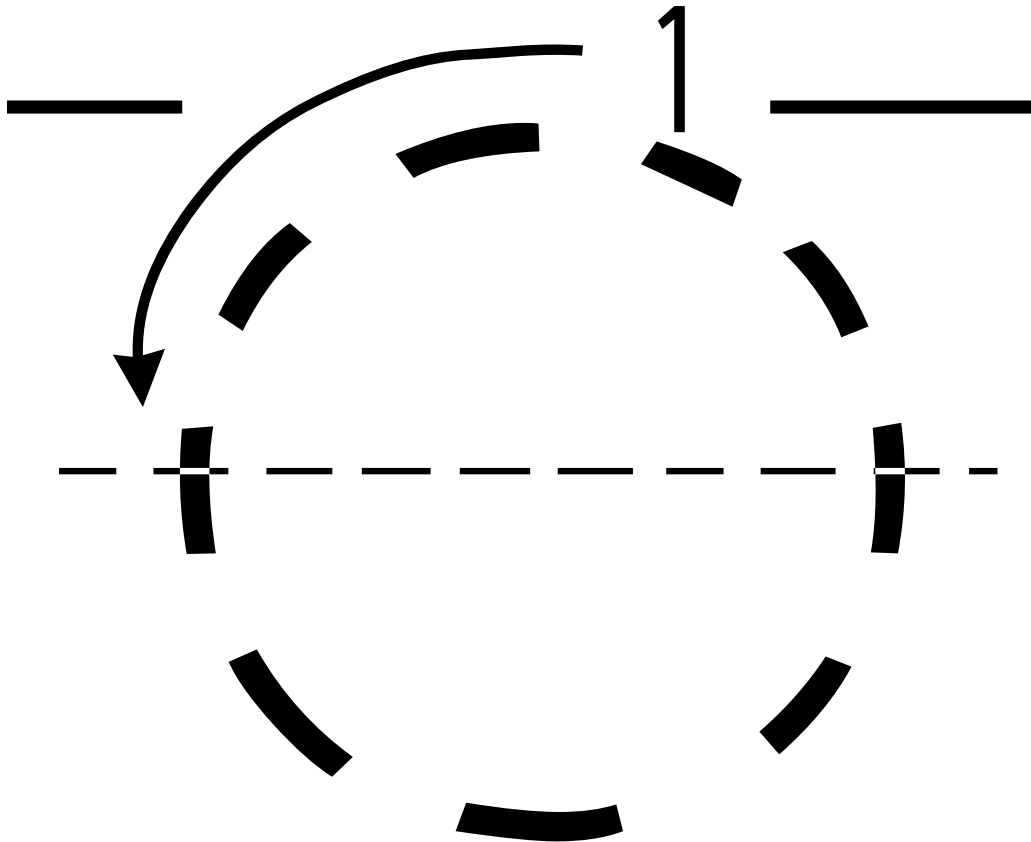

Name: _____

Grade: _____

Date: _____

Alphabet 'P p' Practice Flash card

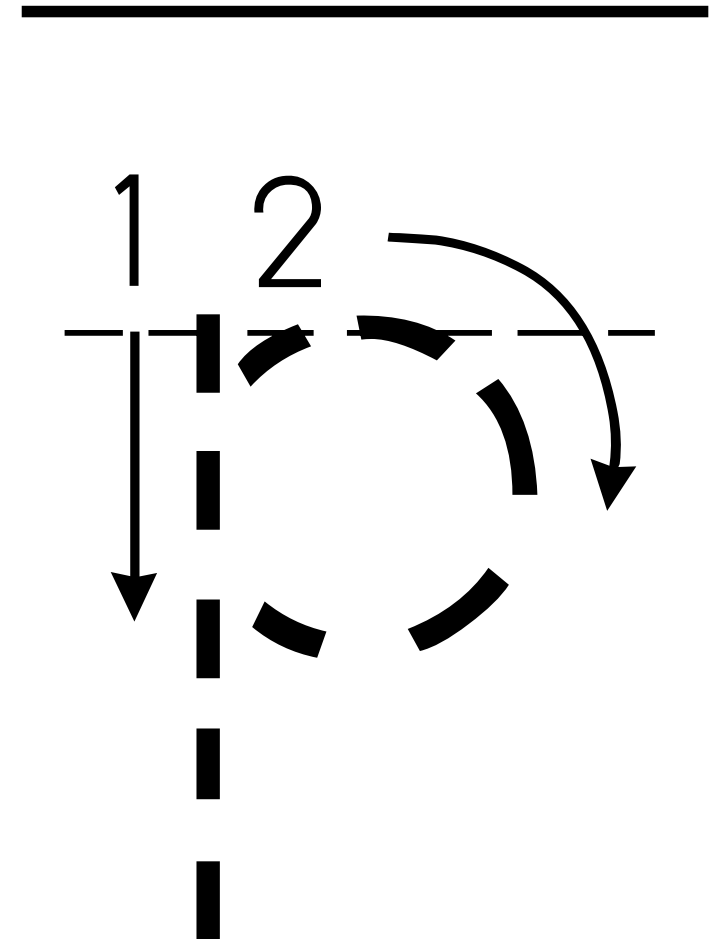
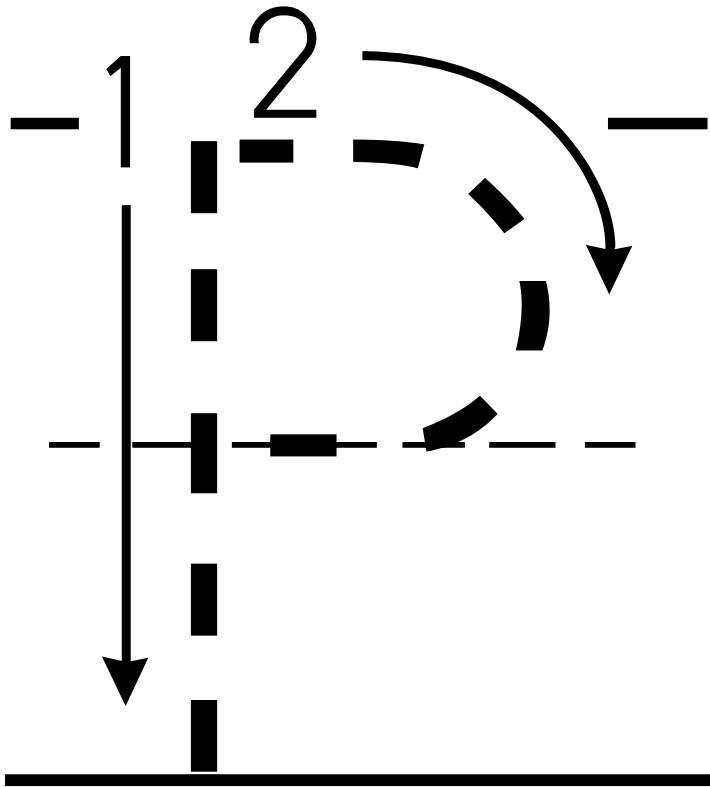

Name: _____

Grade: _____

Date: _____

Alphabet 'Q q' Practice Flash card

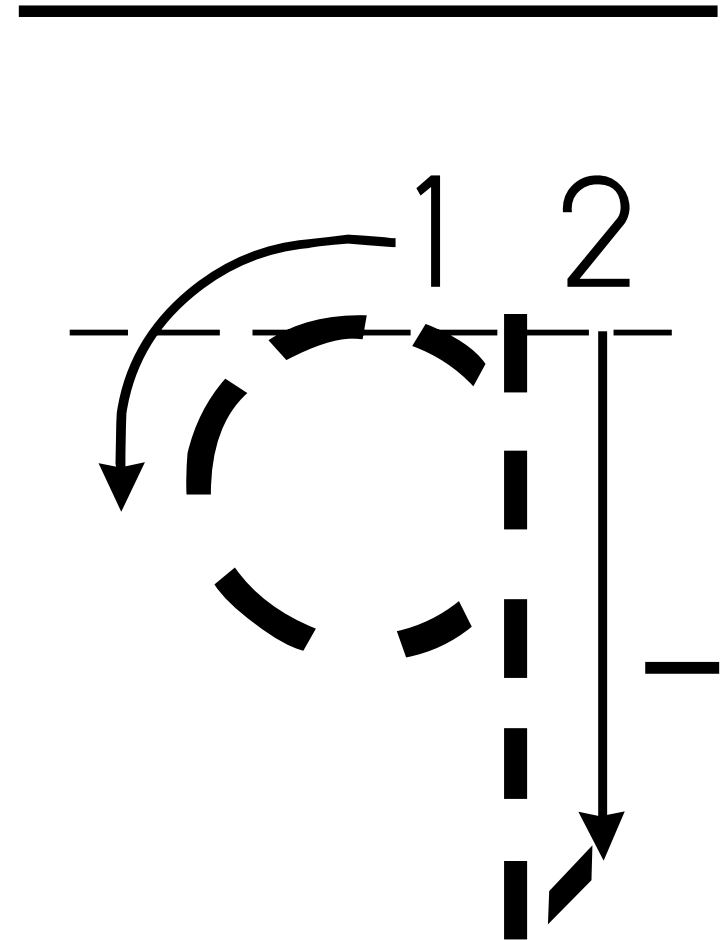
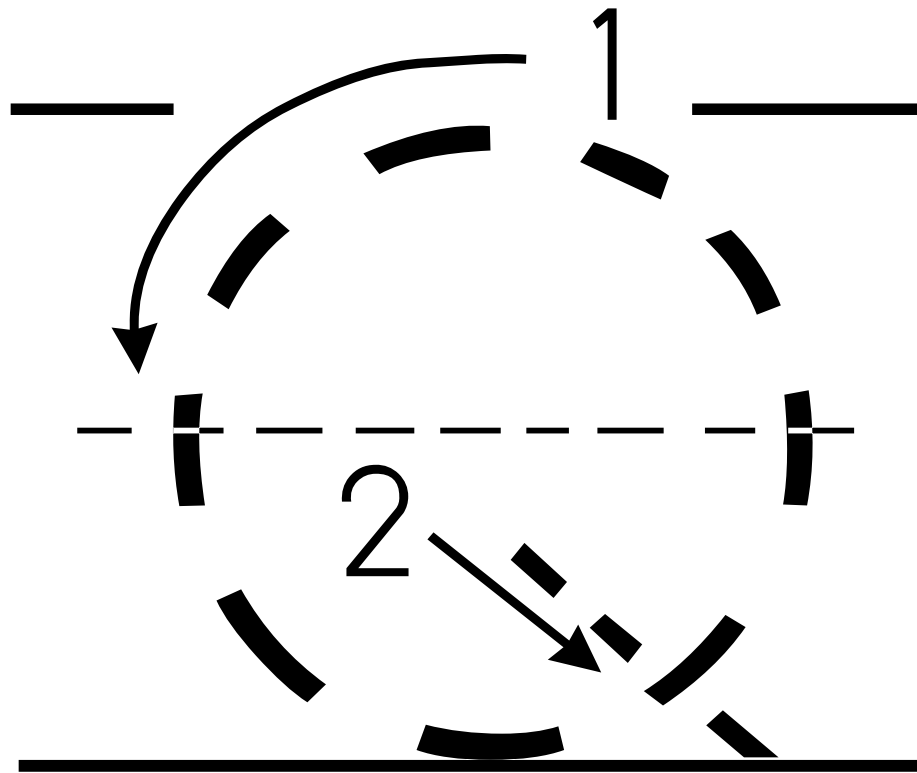

Name: _____

Grade: _____

Date: _____

Alphabet 'R r' Practice Flash card

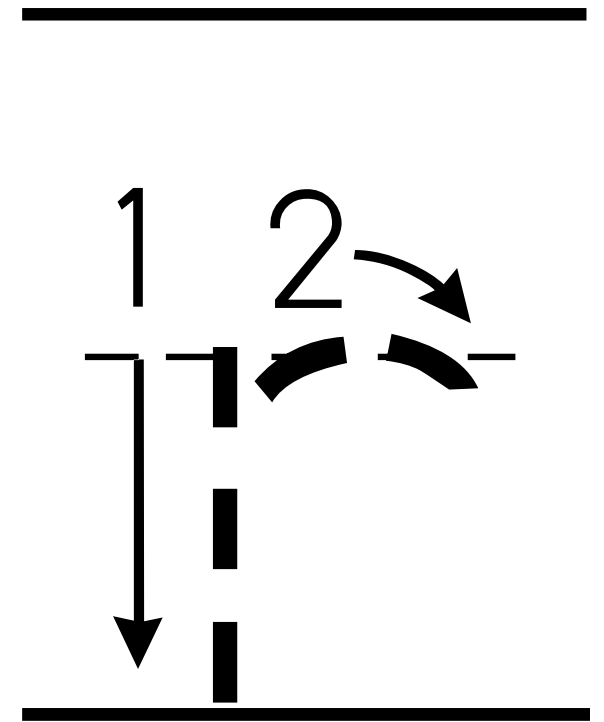
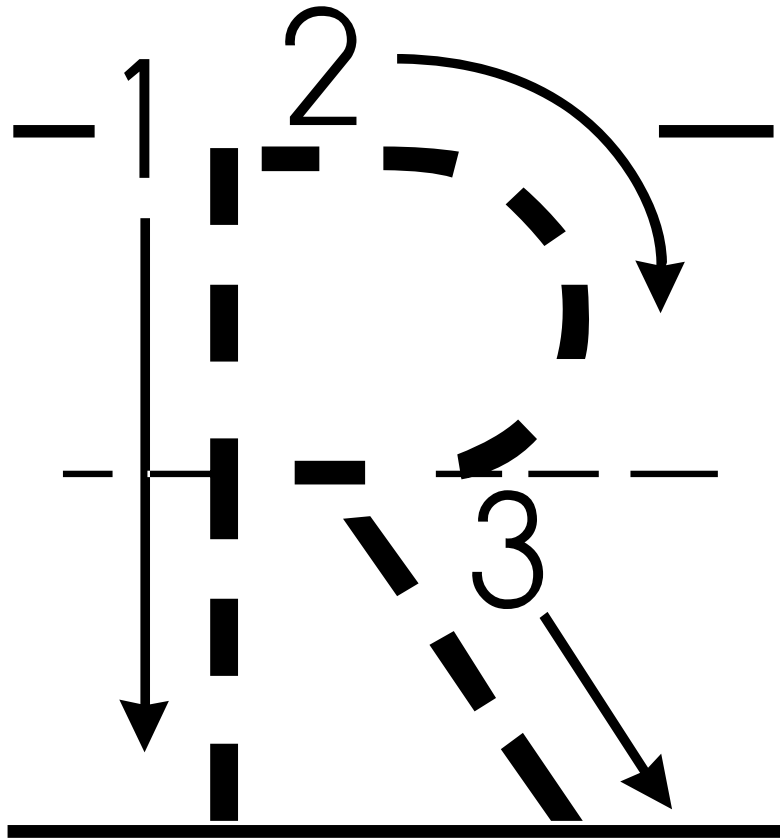

Name: _____

Grade: _____

Date: _____

Alphabet 'S s' Practice Flash card

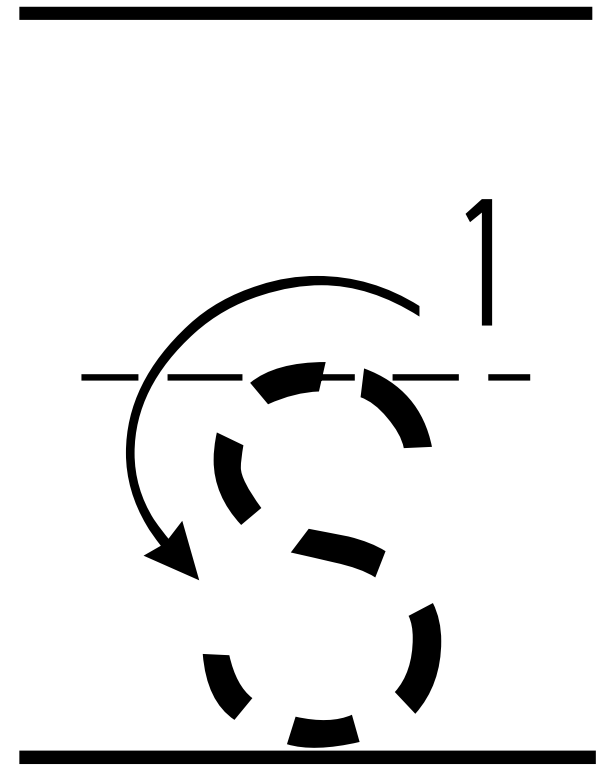
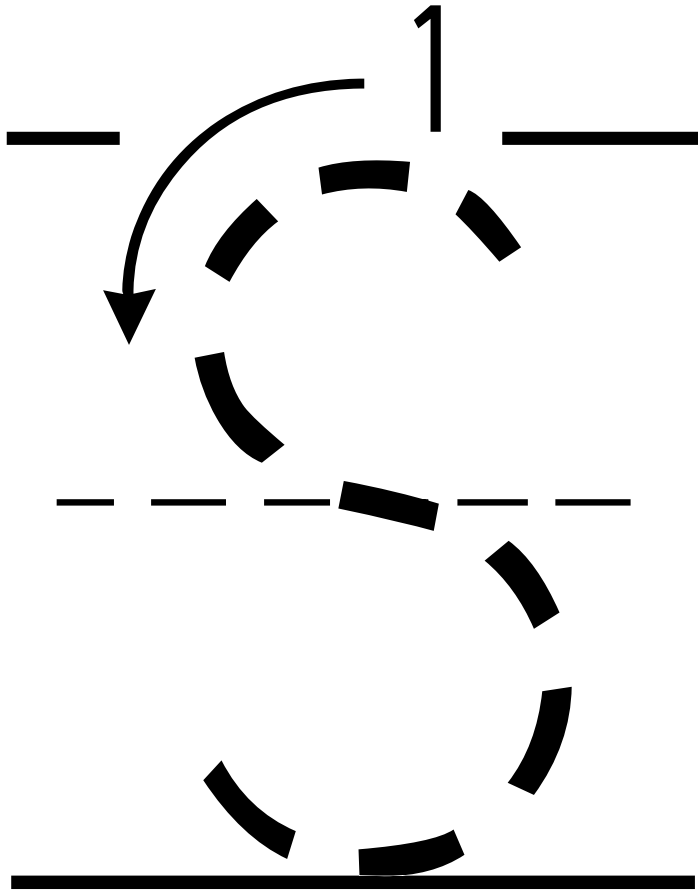

Name: _____

Grade: _____

Date: _____

Alphabet 'T t' Practice Flash card

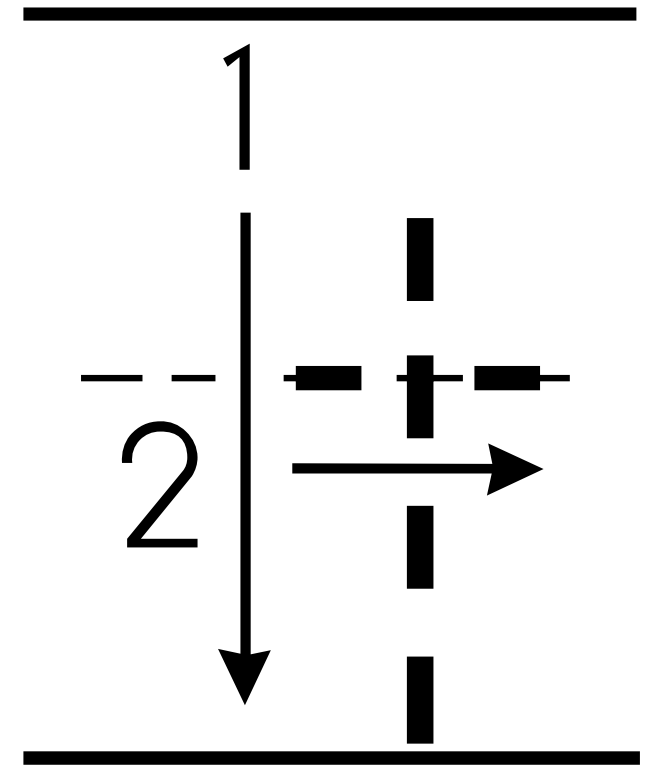
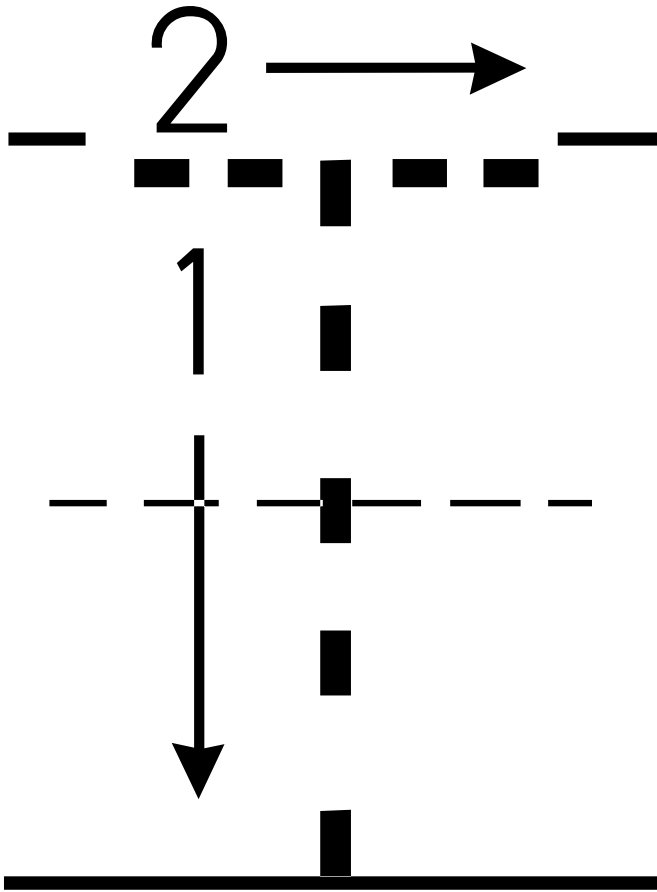

Name: _____

Grade: _____

Date: _____

Alphabet 'U u' Practice Flash card

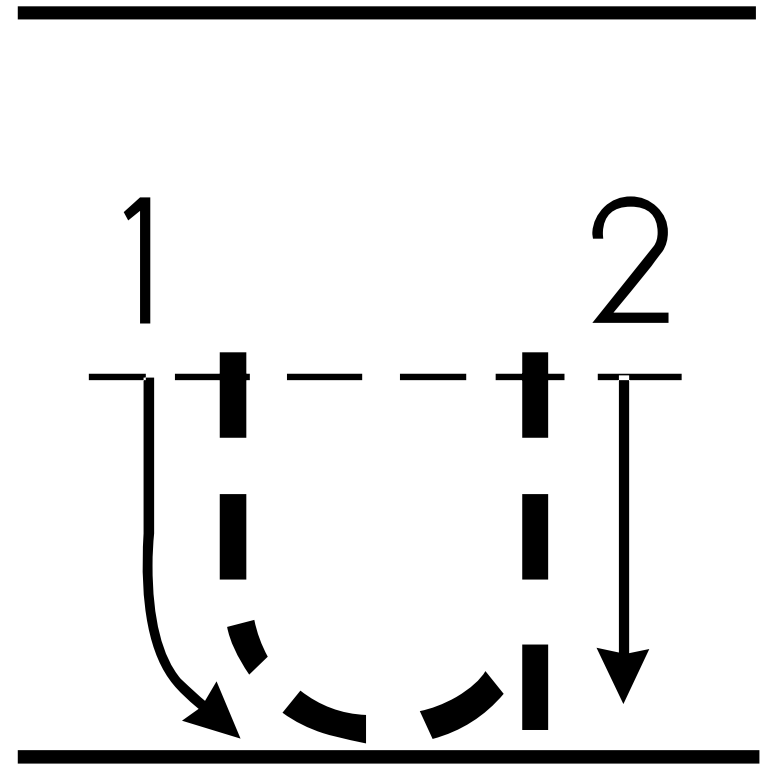
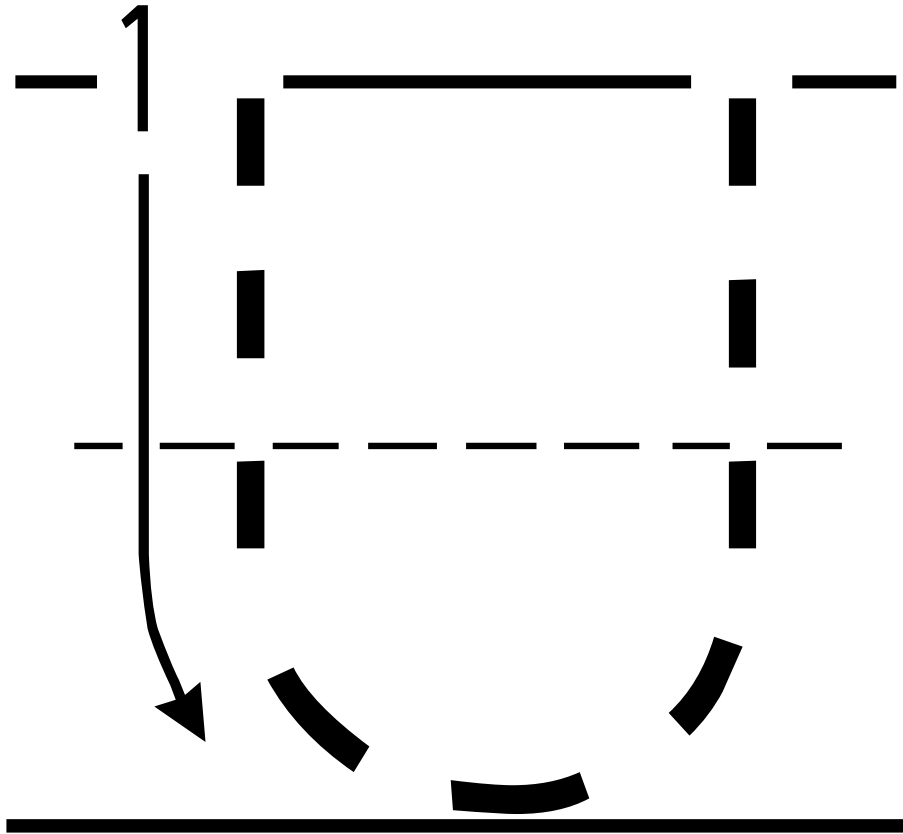

Name: _____

Grade: _____

Date: _____

Alphabet 'V v' Practice Flash card

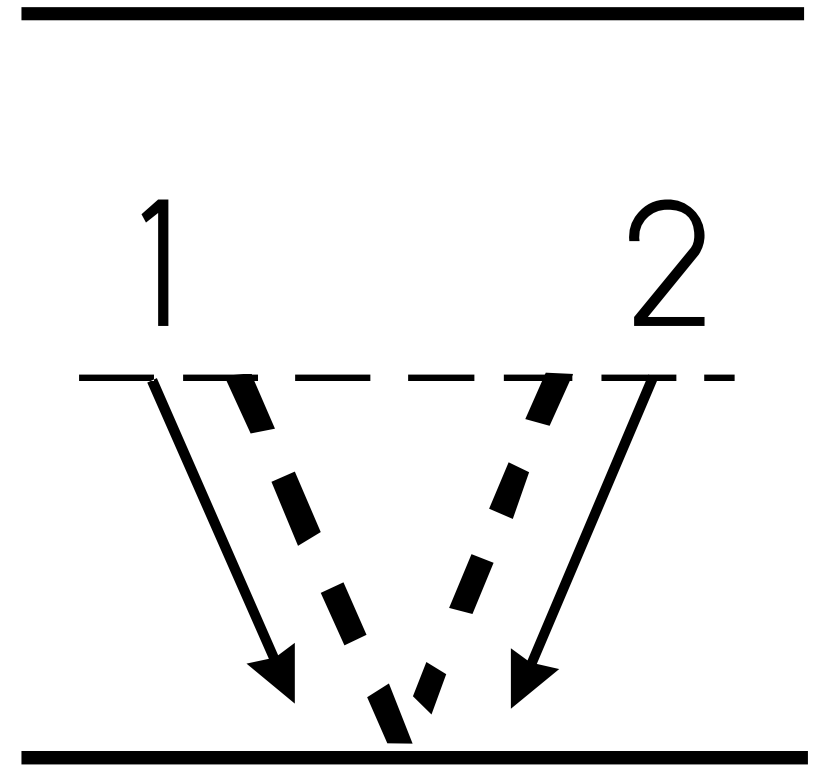
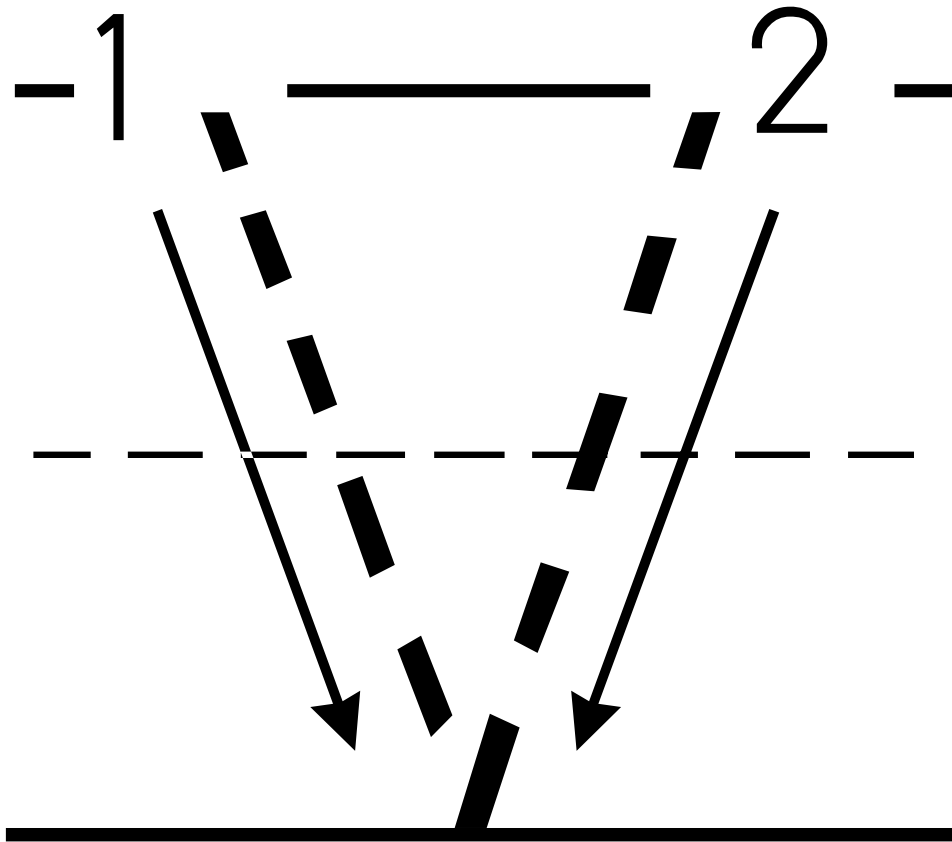

Name: _____

Grade: _____

Date: _____

Alphabet 'W w' Practice Flash card

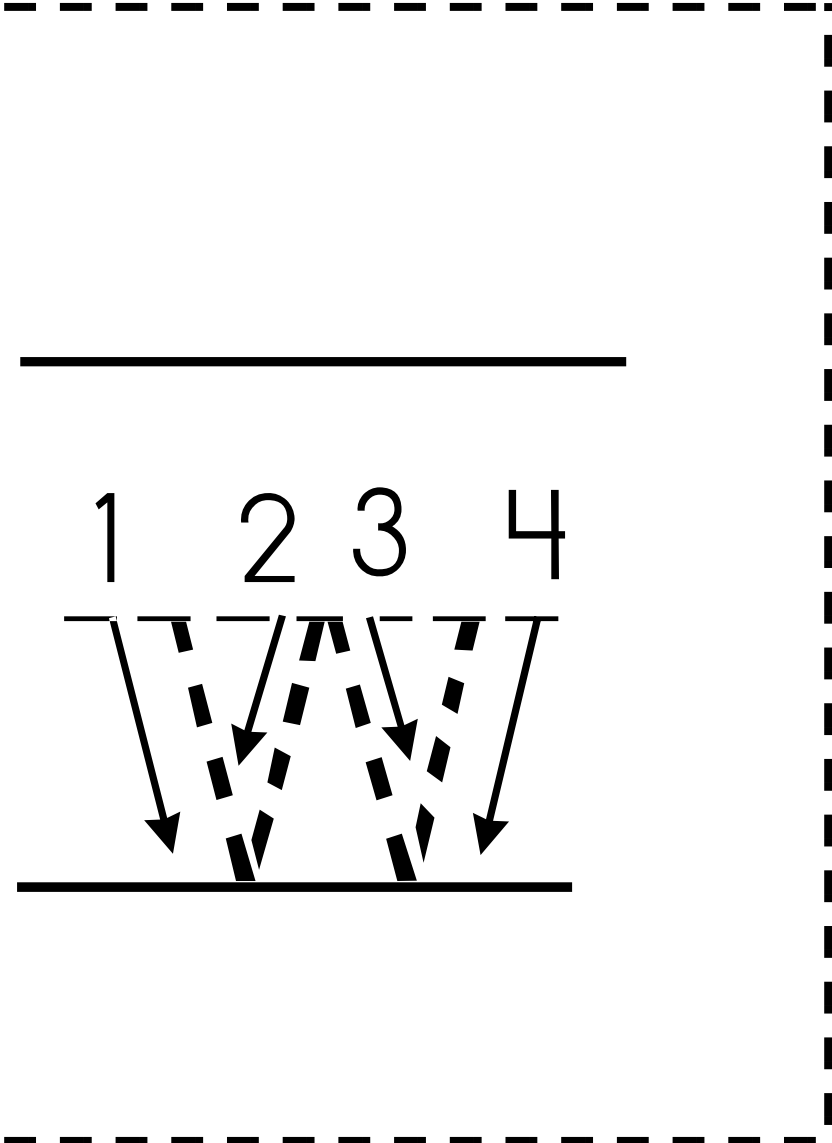
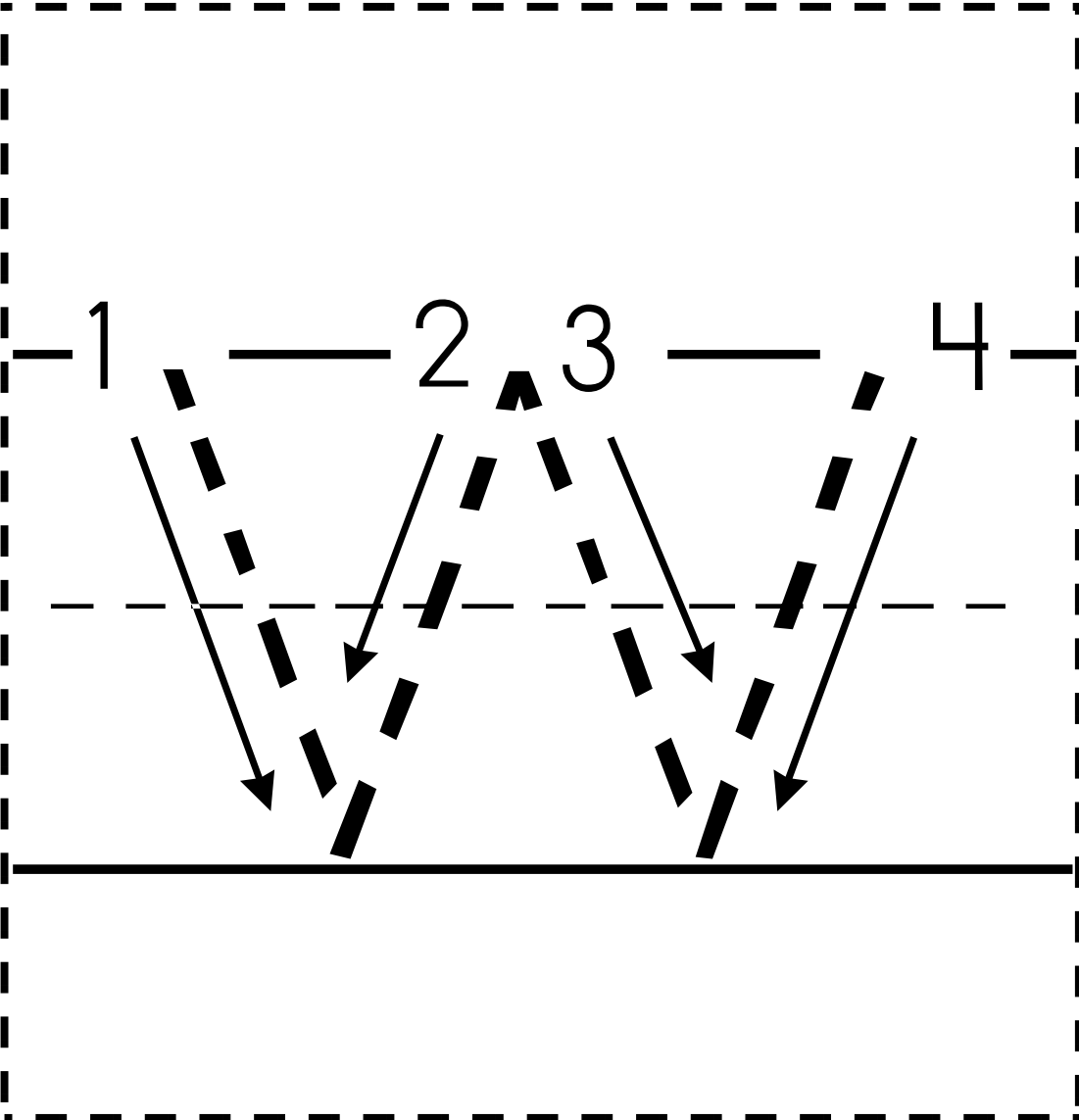

Name: _____

Grade: _____

Date: _____

Alphabet 'X x' Practice Flash card

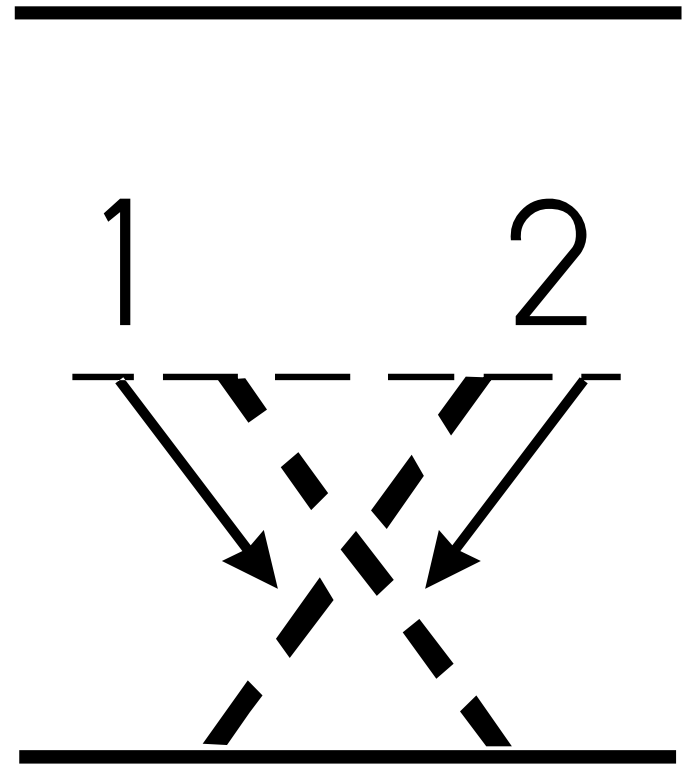
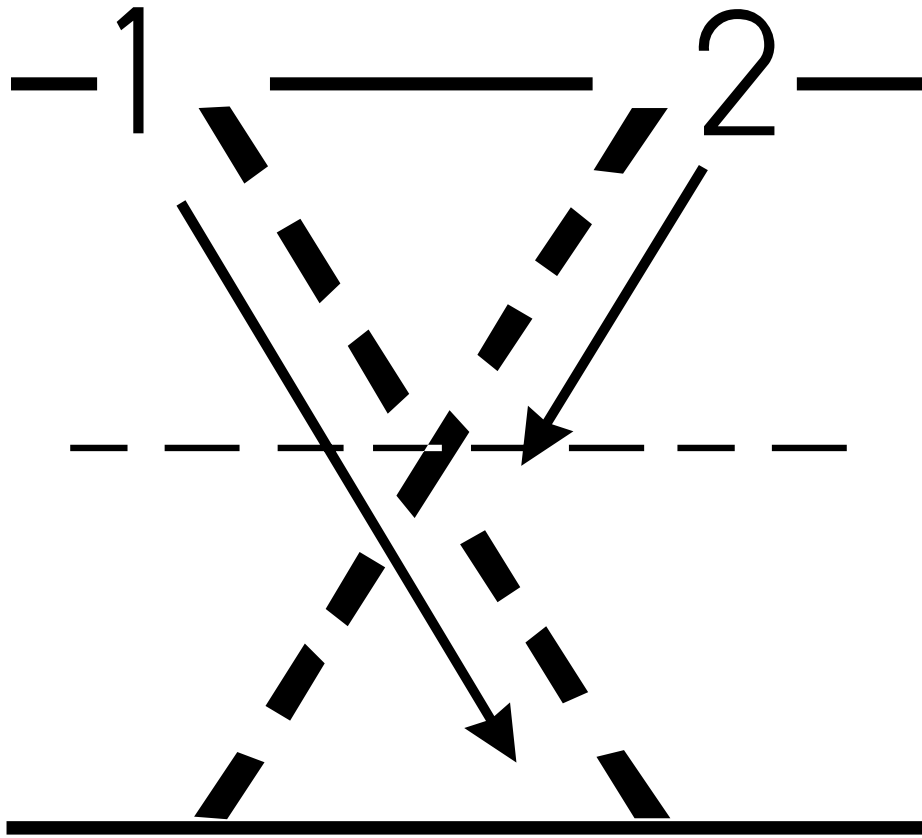

Name: _____

Grade: _____

Date: _____

Alphabet 'Y y' Practice Flash card

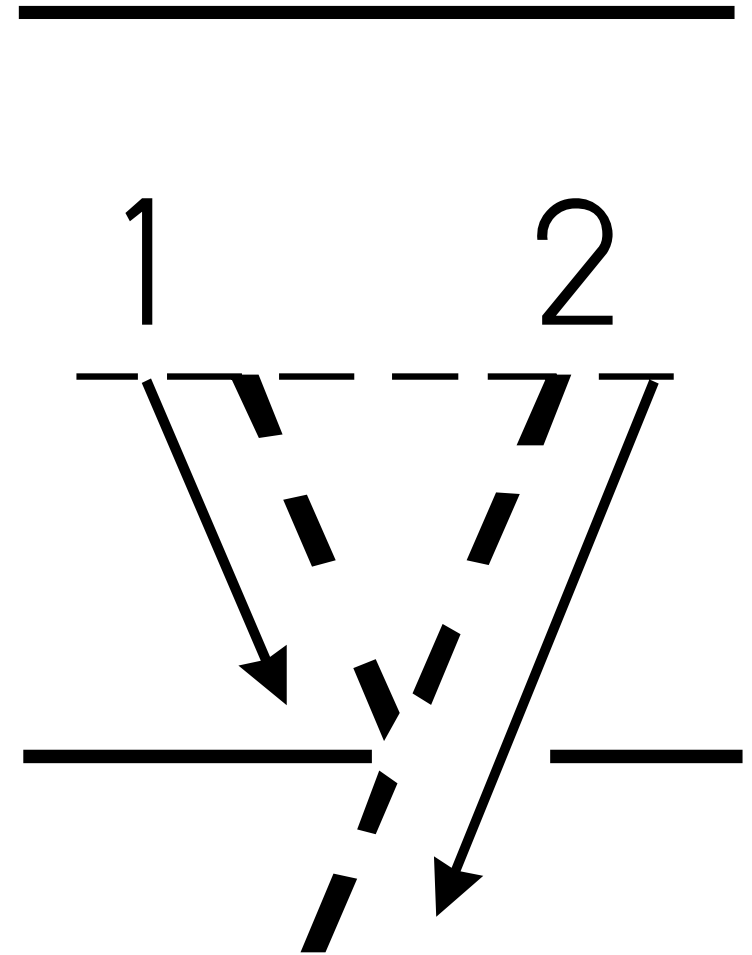
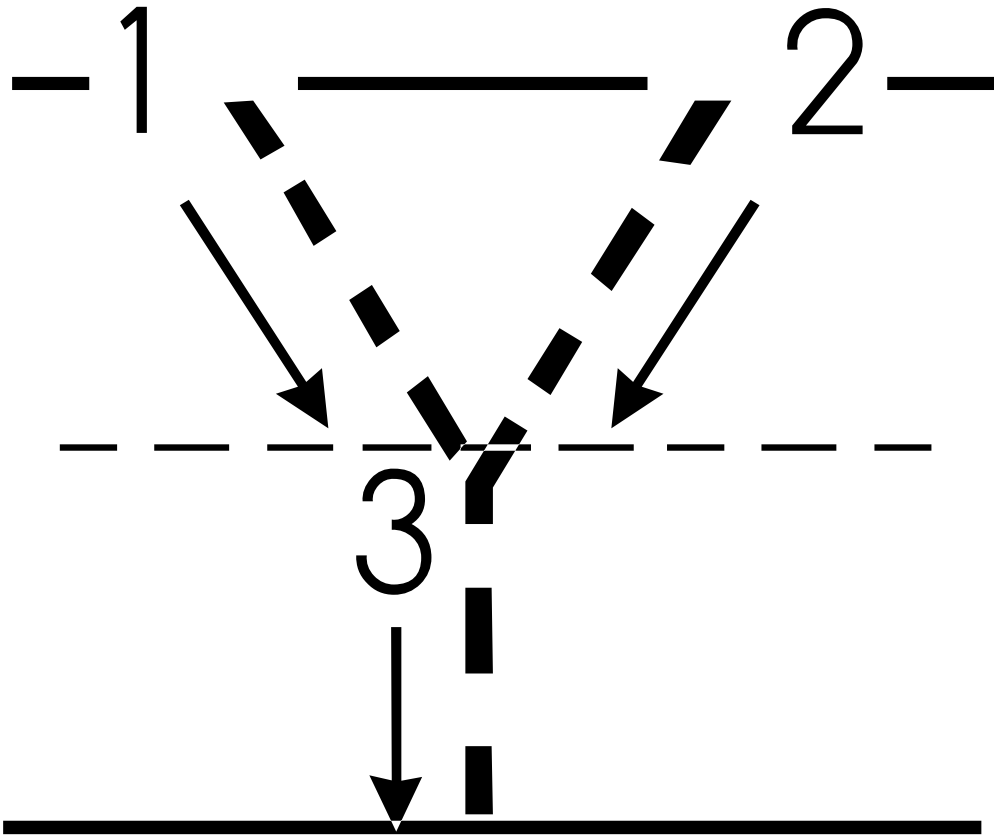

Name: _____

Grade: _____

Date: _____

Alphabet 'Z z' Practice Flash card

